

ERECTION AND MAINTENANCE INSTRUCTIONS

FOR

GRUMMAN AMPHIBIAN

MODEL G-21A

SERIAL NO.

REPORT NO. 1221A

SECTION IGENERAL INDEX

	<u>PAGE</u>
SECTION I	
General index	1
Index of illustrations	2
Grumman Warranty	3
General Specifications	4, 5
SECTION II	
Erection and Maintenance Instructions	
a) General information	8
b) Wings	9
c) Wing Tip Floats	13
d) Tail Surfaces	15
e) Landing Gear	19
f) Tail Wheel	31
g) Power Plant	43
h) Propellers	49
i) Fuel System	50
j) Oil System	54
k) Air Intake System	56
l) Fire Extinguisher System	57
m) Electrical System	59
n) Instruments	62
o) Surface Controls	66
p) Jacking & Hoisting	72
q) Towing & Anchoring	73
r) Ventilating & Heating	75
SECTION III	
Inspection and Lubrication	78
Equipment Record	84, 85
Supplementary Instruction Manuals	86

ILLUSTRATIONSMODEL G-21

<u>FIG.</u>	<u>TITLE</u>	<u>PAGE NO.</u>
1.	Front View and Side View of Airplane.....	6
2.	Three View Drawing.....	7
3.	Wing Connections.....	12
4.	Wing Tip Float Erection.....	14
5.	Tail Erection Installation.....	18
6.	Landing Gear Installation.....	23
7.	Landing Gear Views.....	24
8.	Shock Strut - Landing Gear	28
9.	Shock Strut - Tail Wheel.....	30
10.	Tail Wheel Installation.....	34
11.	Three-quarter Rear View - Tail Wheel.....	35
12.	Brake Controls.....	42
13.	Engine Compartment L.H. Nacelle.....	44, 45
14.	Engine Compartment R.H. Nacelle.....	46
15.	Fuel System Diagram.....	52
16.	Fuel Tanks.....	53
17.	Oil System Diagram.....	55
18.	Fire Extinguisher System.....	58
19.	Wiring Diagram.....	61
20.	Instrument Boards.....	64
21.	Pilot's Cockpit.....	65
22.	Elevator and Rudder Controls.....	69
23.	Flap - Control System Diagram.....	70
24.	Anchor Hatch.....	74
25.	Cabin Interior - Looking Aft.....	76
26.	Cabin Interior - Looking Forward.....	77
27.	Lubrication Chart.....	80

GRUMMAN WARRANTY

We warrant each new airplane sold by us to be free from defects in material and workmanship and service, our obligation under this warranty being limited to making good at the Grumman factories any part or parts thereof which shall, within three months after delivery of such airplane to the original purchaser, be returned to us with transportation charges prepaid, and which our examination shall disclose to our satisfaction to have been thus defective; this warranty being expressly in lieu of all other warranties and representations express or implied and all other obligations or liabilities on our part, and we neither assume nor authorize any other person to assume for us any other liability, in connection with the sale or use of our airplanes.

This warranty shall not apply to any airplane which shall have been repaired or altered outside of the Grumman factories in any way so as, in our judgment, to affect its stability or reliability, nor which has been subject to misuse, negligence or accident, nor to any airplane sold by us which shall have been loaded beyond the factory rated load capacity.

We make no warranty whatever in respect to motors, tires, brakes, ignition apparatus, starting devices, generators, batteries, instruments or other accessories, inasmuch as they are usually warranted separately by their respective manufacturers.

SPECIFICATIONS

THE GRUMMAN "G-21A" AMPHIBIAN

STANDARD EQUIPMENT

GENERAL

- 1 Hull, complete with following compartments:
Nose, with forward entrance hatch in bow, and deep gangway aft to Pilots Compartment.
Pilots Compartment, with large sliding side windows, Plexiglas windshield and entrance door aft to Cabin.
Cabin, complete with side windows, upholstered walls and ceiling, soundproofing, ventilating and heating system, rear entrance door on left side and emergency hatch on right side, door in rear wall to Baggage Compartment.
Baggage Compartment in bow.
Baggage Compartment aft also available for toilet compartment.
- 1 Wing, complete with engine nacelles and statically and dynamically balanced ailerons.
- 1 Wing Flap system, Split type, vacuum operated with two down positions.
- 1 Fin, non-adjustable.
- 1 Rudder, statically and dynamically balanced with controllable tab.
- 1 Stabilizer, non-adjustable.
- 2 Elevators, statically and dynamically balanced with controllable tabs.
- 1 Control system, Dual Wheel type.
- 1 Landing gear, mechanically retractable, complete with hydraulic brakes (pilot's side only) and Bendix struts and wheels. Brake locks for parking.
Tail wheel, retractable with landing gear.
- 1 Tail wheel swivel lock, controllable from cockpit.
- 2 Pilot's seats with safety belts.
- 2 Wing-tip Floats.
- 1 Mooring Cleat.
- 2 Wing Fuel tanks, total capacity, 220 gals.
- 2 Oil Tanks, total capacity, 15 gals.
- 1 Engine Control System.
- 1 CO2 Fire Extinguisher System, two-engine type.
- 1 Pyrene Hand Fire Extinguisher.
- 4 Ash Trays.
- 4 Reclinable Passenger chairs with Safety Belts.
- 2 Fixed Auxiliary Passenger Seats with Safety Belts.
- 1 Cabin Ceiling Light.
- 1 First Aid Kit.
- 1 Airplane Log Book.
- 2 Engine Log Books.
- 1 Set, Erection and Maintenance Instructions. (Not included in empty weight.)
- Baggage Compartment Hold-down Straps, fore and aft compartments.
- 1 Northill Anchor.
- 1 Anchor or Mooring Line.
- 1 Map Container in Pilot's Cockpit.
- 4 Seat Pockets in Cabin.
- 1 Detachable Cabin Door Step.
- Drain Plugs in Hull and Wing Tip Floats.
- 1 Motor Work Shelf (Not included in empty weight)

INSTRUMENTS

- 1 Compass.
- 1 Sensitive Altimeter.
- 1 Airspeed Indicator, Pitot - Static Tube.
- 1 Vertical Speed Indicator.
- 1 Turn and Bank Indicator.
- 2 Manifold Pressure Gauges.
- 2 Oil Temperature, Oil Pressure and Fuel Pressure Gauges.
- 2 Carburetor Air Temperature Gauges.
- 2 Tachometers.
- 2 Fuel Quantity Gauges. (Reading in air or on ground)
- 1 Clock.
- 1 Volt-ammeter.
- 2 Thermocouples, single lead.
- 1 Vacuum Gauge for flaps.

ELECTRICAL EQUIPMENT

- 2 38 Amp. Hr. Storage Batteries.
- 1 Set of Electrical Switches.
- 1 Complete Set, Airplane Wiring, Bonding, Shielding, complete with Conduiting and Junction boxes.
- 2 Radio Headphone Outlets.
- 1 Generator Control box.
- 1 Set, Instrument-board Lights.
- 1 Landing Light.
- 3 Position Lights.
- 1 Mooring Light.
- 1 Landing Gear Warning Light, with Shutter for Night Landings.
- 1 Trouble Light Receptacle.

POWER PLANT

- 2 Pratt & Whitney, Wasp Jr. "S.B." engines. Full Automatic Valve Lubrication.
- 2 Hamilton - Standard Controllable Pitch Propellers.
- 1 Scintilla Engine Switch. (Two-engine type)
- 2 Eclipse Direct Electric Starters, with hand crank attachment, booster coil and solenoid.
- 1 25 Amp. Generator.
- 1 Vacuum Pump.
- 2 Engine Fuel Pumps.
- 1 Emergency Hand Fuel Pump.
- 2 Fuel Strainers.
- 2 Complete Sets, Pratt & Whitney Engine Radio Shielding.
- 2 Complete Sets, N. A. C. A. Engine Cowling.
- 2 Complete Sets pressure type cylinder baffles.
- 2 Oil Radiators and Automatic Temperature Regulators.
- 2 Stainless Steel Exhaust Collector Rings.
- 2 Pratt & Whitney Tool Kits. (Not included in empty weight)

SPECIFICATIONS

THE GRUMMAN "G-21A" AMPHIBIAN

AIRPLANE DATA

Airplane Type	8 Place Amphibian Monoplane
Number of Engines	Two
Controllable Pitch Propellers	Hamilton - Standard
Landing Gear Retractable	Mechanically
Wing Flaps	Vacuum - Two Position
Soundproofing	Sperry
Hull and Body Structure	All Metal
Wing Structure	All Metal
Empennage Structure	All Metal
Shock Absorber Units	Bendix

ENGINE DATA

Engines (2)	Wasp Jr. "S. B." Pratt & Whitney
Type	Radial Air Cooled - 9 Cylinders
Horsepower and RPM - Take-Off	450 at 2300 with 87 Octane
	400 at 2200 with 80 Octane
Maximum Horsepower for Continuous Operation	400 at 2200 (Up to 5000 ft. Critical Altitude)
Cruising Horsepower (Recommended)	300 at 2000 r. p. m.

AIRPLANE DIMENSIONS

Length	38' 4"	11.70 M.
Span	49' 0"	14.95 M.
Height (On three wheels)	12' 0"	3.66 M.
Wheel Tread	7' 6"	2.28 M.
Wing Area	375 Sq. Ft.	34.80 Sq. M.

AIRPLANE WEIGHT DATA

Gross Weight	8000 Lbs.	3630 Kgs.
Empty Weight	5475 "	2470 "
Useful Load (Standard Equipment)	2525 "	1155 "
Maximum Oil Capacity (15 U. S. Gals.)	112 "	51 "
Normal Fuel Capacity (175 U. S. Gals.)	1050 "	476 "
Maximum Fuel Capacity (220 U. S. Gals.)		
Wing Loading	21.3 lbs. per Sq. Ft.	103.8 Kgs. per Sq. M.
Power Loading (Take-off Power)	8.9 lbs. per HP.	4.02 Kgs. per HP.

AIRPLANE PERFORMANCE (8000 lbs.)

Maximum Speed at 5000 ft. (1525 M)	201 M. P. H.	324 Km. P. H.
Maximum Speed at Sea Level	191 "	307 "
Cruising Speed at 9600 ft. (2930 M) (600 H. P.)	190 "	306 "
Cruising Speed at 5000 ft. (1525 M) (600 H. P.)	180 "	289 "
Cruising Speed at 5000 ft. (1525 M) (500 H. P.)	170 "	273 "
Cruising Speed at Sea Level (600 H. P.)	171 "	274 "
Maximum Rate of Climb at Sea Level	1,300 Ft. per Min.	396 M per min.
Climb to 5000 ft. (1525 M)	4.5 Min.	4.5 Min.
Climb to 9600 ft. (2930 M)	10.0 Min.	10.0 Min.
Service Ceiling	22,000 Ft.	6700 M
Absolute Ceiling	24,000 Ft.	7320 M
Ceiling with One Engine (8000 lbs.) (3630 Kgs.)	6,000 Ft.	1825 M
Take-off Run at Sea Level	820 Ft.	250 M
Take-off Time at Sea Level	12 Secs.	12 Secs.
Take-off Time as Seaplane (Calm, glassy)	19 Secs.	19 Secs.
Landing Speed at Sea Level (Flaps Down)	62 M. P. H.	100 Km. P. H.
Fuel Consumption at 600 H. P.	51 U. S. Gals. per Hr.	
Fuel Consumption at 500 H. P.	40 U. S. Gals. per Hr.	
Fuel Consumption at 400 H. P.	32 U. S. Gals. per Hr.	

RANGE — PAYLOAD TABLE

Horsepower	Altitude	Fuel	Speed	Payload (With 1 Crew)	Range
75%	9600	175	190	1205	610
75%	5000	175	180	1205	580
62½%	9600	175	180	1205	740
62½%	5000	175	170	1205	700
50%	5000	220	150	920	1000

These Figures Allow 10 Gallons for Warm-up and Climb to Altitude

Guaranteed within 3%:—

Weight Empty

Guaranteed within 5%:—

Max. Speed at Sea Level
Service Ceiling

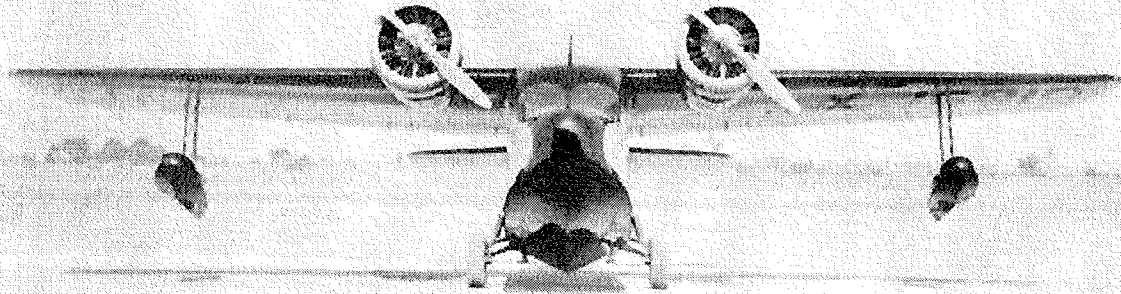

G21A - FRONT VIEW OF AIRPLANE

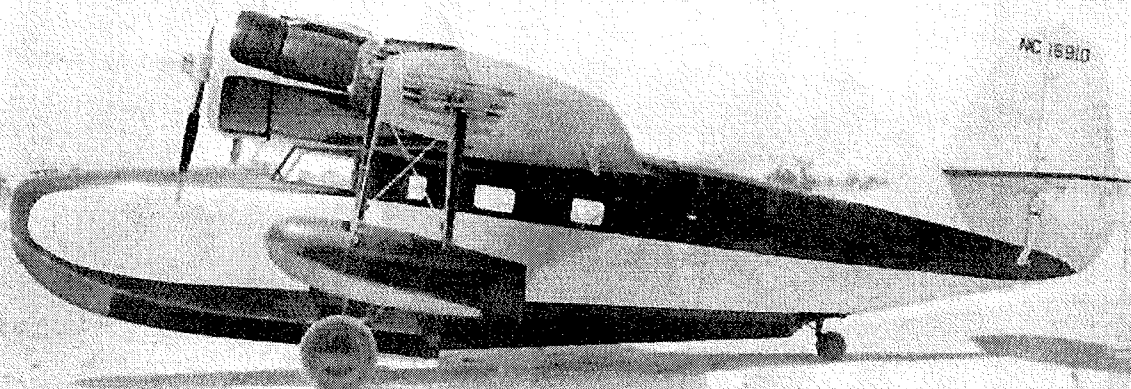

A
G21 - SIDE VIEW OF AIRPLANE - Fig 1

The GRUMMAN "G-21A" AMPHIBIAN

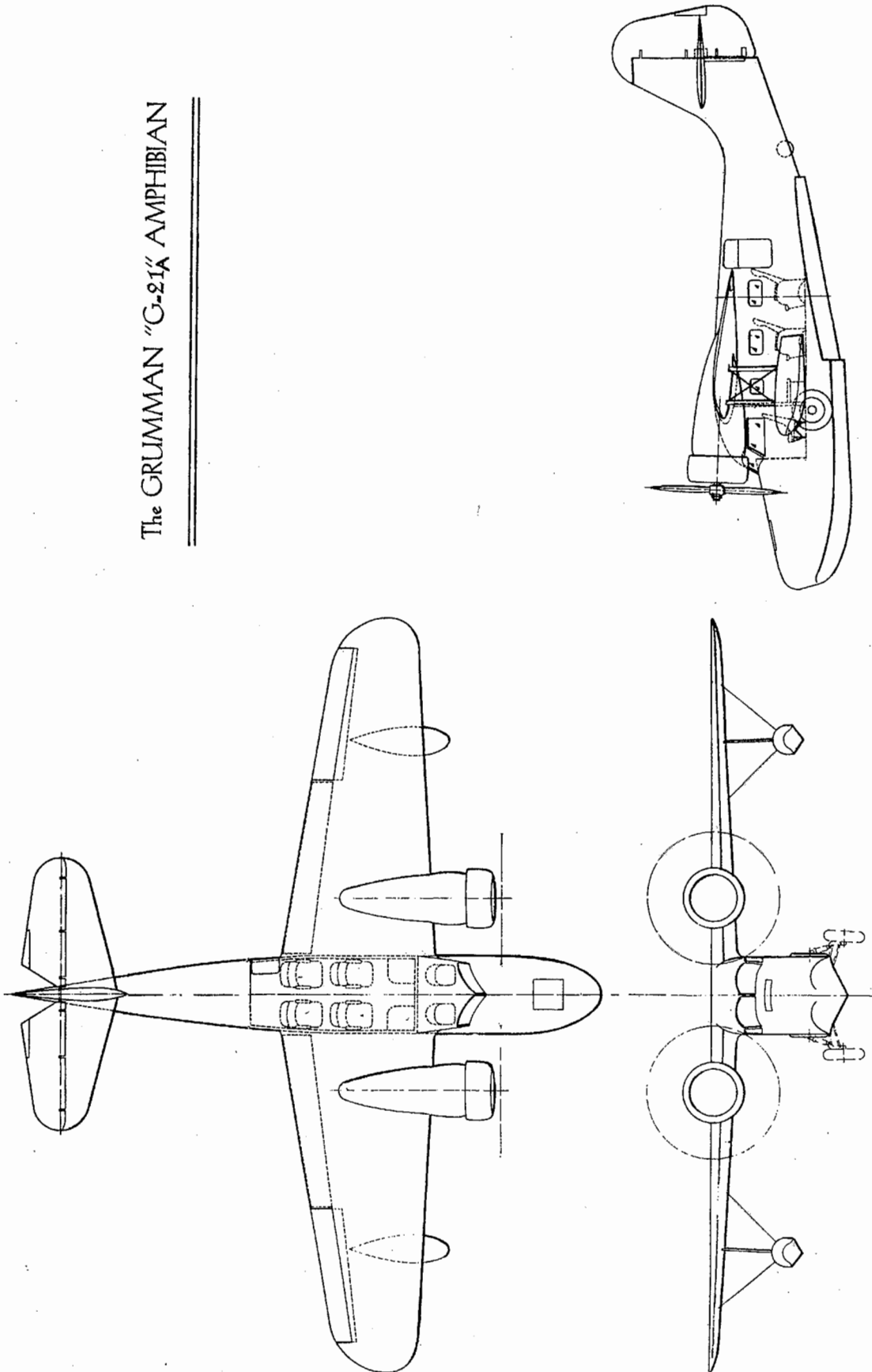

GRUMMAN AIRCRAFT ENGINEERING CORP.
BETHPAGE, LONG ISLAND

SECTION IIERECTION AND SERVICE INSTRUCTIONS(a) General Information

This airplane is a dual control, eight place, all metal, twin engined, high wing, cantilever, monoplane amphibian; the hull of which is an integral part of the body; the wing center section, which includes the engine nacelles, being permanently bolted to the top of the body.

The landing gear wheels are mechanically retracted into the hull sides.

The hull lines for all practical consideration are identical with those of the Grumman Amphibian supplied to the U.S. Navy and U.S. Coast Guard.

Wing tip floats of standard line and construction are fitted to the outer wing panels.

The engines are Pratt & Whitney Wasp Junior, radial, air cooled, model S-B, engines rated 450 H. P. at 2300 r. p. m. (87 octane fuel) for takeoff and 400 H.P. at 2200 R.P.M. at 5000 ft.

(b) Wings

Units

The wing structure consists of; the center section which carries the engine nacelles and the "built-in" fuel tanks, the outer wing panels, the ailerons, the flaps and the wing tip floats.

Wing erection on this airplane is specifically a factory job.

The center section is attached at the box beam by eight (8) vertical large dia. bolts at points of intersection of the box beam sides and sides of hull. The portions aft and forward of the box beam are permanently attached to the hull by means of extended angular brackets and gap bands.

The outer wing panels are attached to the center section at the box beam by means of a series of vertical clevis bolts and horizontal hex-head bolts and at the aileron support beam by a series of hex. head bolts. The joint between the outer panel and the center section is covered by plates fastened in place by means of clevis bolts at the box beam and Grumman Standard screws* aft of the box beam.

The wing flaps are the split balanced type and each is attached to the wing at four (4) hinges by means of hex head bolts. The flap actuating cylinder and return control spring are located just outboard of the wing center section under the rear gap plate. The return control spring is hooked in place and the cylinder is bolted in place with hex head bolts. All flap hinges are equipped with grease packed ball bearings.

* Part number G7-8-7 - replacements obtainable only from the Grumman factory.

Each aileron is attached to the outer wing panel by means of hex. head bolts at the three (3) hinges. The control horn is located near the inboard end. The push-pull control tube which mates with the horn is adjustable and extends directly into the wing, being faired at this point by a hood. All aileron hinges are equipped with grease packed bearings. (See wing illustration).

To Correct for Wing Heaviness.

After flight testing, if it is found that the airplane is "wing heavy", this condition may be quickly and effectively remedied by slightly crimping up the aileron trailing edge tab on the heavy side. Care should be taken not to crimp the aileron tab too severely. A very slight amount of crimping will correct for a considerable amount of wing heaviness.

Connections - Miscellaneous Wing

Wiring

All electric wiring in wing panels is carried in aluminum alloy conduit, flexible conduit being used at light fixtures and at panel connections.

The left outer panel is fitted with one landing light and motor assembly, in lower surface; one red passing light,^{*} in leading edge, and one running light in wing tip. The right outer panel is fitted with one running light in wing tip. Each engine nacelle is fitted with one six post terminal block housed in a junction box. The main junction box from which current is supplied to wing lights, is located in the body just above the co-pilot on the bulkhead aft of the pilot seats.

The generator, one only, is mounted on the right hand engine.

* If installed.

Flap Controls in Wing

The flap control actuating cylinder assembly, in each wing panel is a double cylinder two position type and is pivotally mounted to the structure. Lines in the wing to the cylinder assembly and to the engine are aluminum alloy tubing $3/8$ dia., connected by aluminum alloy compression type fittings except at the cylinder and engine attachment points where $5/16$ I.D. vacuum hose and hose clamps are used.

Aileron Controls in Wing

The aileron control in the wing consists of push rods and bell cranks operated from a central bell crank located on the front face of the box beam. All bell cranks are fitted with ball bearings.

Airspeed Tubing

The airspeed pitot static tube is located on a boom that extends forward from the leading edge of the right wing. Lines in the wing to the pitot static tube are $3/16$ dia. aluminum alloy tubing connected by aluminum alloy compression fittings and run along the wing in the leading edge to the airplane body. Drain tees are located in the airplane body under the co-pilot's sliding window and on the front of the firewall at the R.H. wing joint.

Revision 5/15/38

(c) Wing Tip Floats

The wing tip floats, 760# displacement each, are of standard lines and construction, and are attached to the wing outer panels by vertical struts (two per float) and streamline bracing tie-rods. The floats are identical and may be used on either side of the airplane.

To assemble the wing tip float, first attach the struts and fore and aft bracing to each float, then attach the assembly as a unit to wing panel and then install the transverse bracing tie-rods.

Adjust both fore and aft bracing and the transverse bracing to bring the struts into position as shown on illustration shown in this manual.

(d) Tail Surfaces

The tail unit which comprises a single cantilever fin with hinged rudder and individually strut braced left hand and right hand stabilizers with hinged elevators, is supported at the rear of the body. Rudder, elevators and stabilizers may be removed. (See tail erection diagram).

The units are constructed and attached in the manner as hereafter described.

Fin

The fin is a built-up frame, skin stressed aluminum alloy structure and is riveted to the body.

An attachment fitting is provided on the fin leading edge near the top for the radio antenna.

Rudder

The rudder is a cloth covered internally braced aluminum alloy structure and is provided with four hinges which are fitted with grease packed ball bearings. The two upper hinges are bolted to the fin rear beam and the two lower hinges are bolted to the stern post (rear bulkhead of body).

The rudder is fitted with electrical conduit and is wired for the anchor light(at top) and the running light (at trailing edge).

The rudder control horns are rigidly fixed to the rudder structure and should not be disconnected when removing the rudder from the airplane. The control cables, tab control shaft and electric wiring should be disconnected when removing the rudder.

Stabilizers and Struts

The stabilizers (left and right) are the same type structure as the fin and are attached to the body structure at Station 33 and at the stern post by aircraft bolts.

The stabilizer bracing struts are located below the stabilizers and are attached by standard aircraft bolts.

Pairing sleeves are provided at all strut terminals.

Stabilizers are not adjustable.

Elevators

The elevators are cloth covered internally braced structures like the rudder. They are provided with seven hinges which are fitted with grease packed ball bearings. The hinges are bolted to the stabilizer rear beam. The elevators are connected together and cannot be removed individually.

The control horn is rigidly fixed to the elevator structure and should not be disconnected when removing the surface from the airplane. Control cables and tab control shafts should be disconnected when removing the elevators.

Balances

The rudder is statically balanced and the elevators are dynamically balanced.

Flaps

The wing flaps are vacuum controlled and may be drooped to two positions. The system consists of a vacuum tank located in the bow compartment, a control valve located on the upper instrument panel, check valves in the engine lines, short flexible hose connections at the engines, long flexible hose connections at the cylinders, two double actuating cylinder assemblies located in the wings, aluminum alloy (5250) lines and compression type aluminum alloy fittings. (See diagram page 12 and page 70).

The source of vacuum supply is the engine itself, the connection being in the carburetor adapting plate, connecting to the intake system just above the carburetor. Vacuum connections are fitted to both engines with individual check valves so that a supply is assured with either engine completely out of action. In addition, the vacuum storage tank is sufficiently large to operate the flaps at least twice with both engines out. (Engines will produce vacuum with throttle closed unless completely stopped even though switch is out.)

As the most vacuum is produced when throttle is tight closed, always close throttles and maintain a fast glide for a few seconds before lowering flaps, to insure building up a good vacuum in the system.

NOTE: A tight vacuum system is essential for emergency operation of the flaps. To check tightness, operate flaps before starting motors. If flaps operate briskly after the ship has stood idle for 24 hours or more, the system is OK.

Tabs

The rudder and each elevator is fitted with a controllable tab, small push rod and irreversable screw type actuator.

REPORT NO. 1221

(e) Landing Gear

General

The landing gear is of the retractable type, enabling the entire landing gear to be withdrawn into the hull after take-off, thus materially reducing the drag of the airplane, and increasing the performance and efficiency. When the gear is retracted, the hull bottom and sides are smooth and uninterrupted.

The type of retractable mechanism is identical with that in use on the latest type amphibian built for the U. S. Navy by the Grumman company.

Retracting Operation

The landing gear is retracted or extended by means of a hand crank (selective ratchet type) conveniently located in the pilot's cockpit between the pilot's seat and the co-pilot's seat. Approximately 41 turns of the crank are required to raise or to lower the gear. The crank is turned clockwise to lower the gear and counter-clockwise to raise the gear. The hand crank is automatically latched by a ratchet within the housing acting on the crank handle shaft while the wheels are being moved. This ratchet is reversed when gear is to be raised or lowered, by operating a small lever just to the left of the hand crank.

NOTE: After releasing this ratchet lever, the crank still remains locked until pressure is exerted on the crank opposite to the desired rotation.

Position of Wheels

The crank is rotated as far as it will go in the desired direction, either to raise or to lower the gear. The wheels should then be in the desired position. If desired, the position of the wheels can be checked by viewing the gear through the small windows provided for this purpose.

The selective ratchet provided within the hand crank may be used to advantage when cranking past a "high torque" point while raising or lowering the gear.

Wheel Lock

When the gear is cranked down to fully-down position, a spring counter-balance unit automatically comes into action which prevents all possibility of the gear retracting during landing or takeoff. No control is necessary on this unit, since it is so located and designed that it will always exert the proper force. If removed care should be taken to replace the counter-balance link in its proper position. See landing gear installation drawing, page 23.

Landing Gear Warning Light

A red jewel warning light is provided on the instrument board which will light whenever the engines are throttled below 1200 R.P.M. regardless of position of wheels.

This installation is provided as a safety measure to remind the pilot to put the landing gear in proper position to land.

Adjustment and Synchronization of Landing Gear

Caution: The airplane should be supported as follows when it is desired to check the operation of or remove the landing gear; in the front, under Sta. 7 bulkhead and in the rear under the main step bulkhead. See page 72.

With the tail wheel assembly and both sides of the landing gear (including counter-balances and gear boxes) mounted in the airplane proceed as follows:

1. Support the airplane in the usual manner, under hull.
2. Have the operating shafts disconnected at flanged joint.
3. Insert and tighten the three (3) special $9/32$ dia. bolts, between flanged torque tube and compression link on each side.
4. Open the shock strut knuckles and insert $3/32$ inch shims $1/4$ inch into the open end of the joints. Allow the joints to close tight on the shims. (If the knuckles cannot be opened sufficiently to permit insertion of the shims, turn the operating shafts until the joint can be opened).
5. With one man at each wheel watching the rotation of operating shafts, wind hand crank down hard against the stop. Turn flanges on worm gear boxes in opposite direction by hand as far as they will go. Bolt up mating holes in operating shaft flanges.
6. Connect tail wheel cables and chain. See pages 31 and 32.

Safety Bolts

In order to protect the landing gear retracting mechanism from possible damage such as might occur by beaching the airplane with the wheels partly down or by violent wave action when extending the gear on the water, the upper oleo strut link is connected to the retracting mechanism by 3 - ^{5/16"}~~9/32"~~ bolts #12646 (See paragraph 3 on previous page) which are intended to shear off before the mechanism can be damaged by excessive loads. These bolts are amply strong for all retracting operation loads, but are not strong enough to support the airplane with the landing gear partly retracted.

CAUTION: Never attempt to jack up the airplane by lowering the wheels or put any load on the wheels unless the landing gear is fully down.

In case the wheels inadvertently touch bottom during beaching before the gear is fully down, always immediately remove and inspect one of these bolts on each side. If at all marked replace all three on each side. In any case inspect one bolt from each side at every 20 hour check.

These bolts are special aircraft bolts, part number 9646 and must be purchased direct from the factory.

REVISED 5/19/53

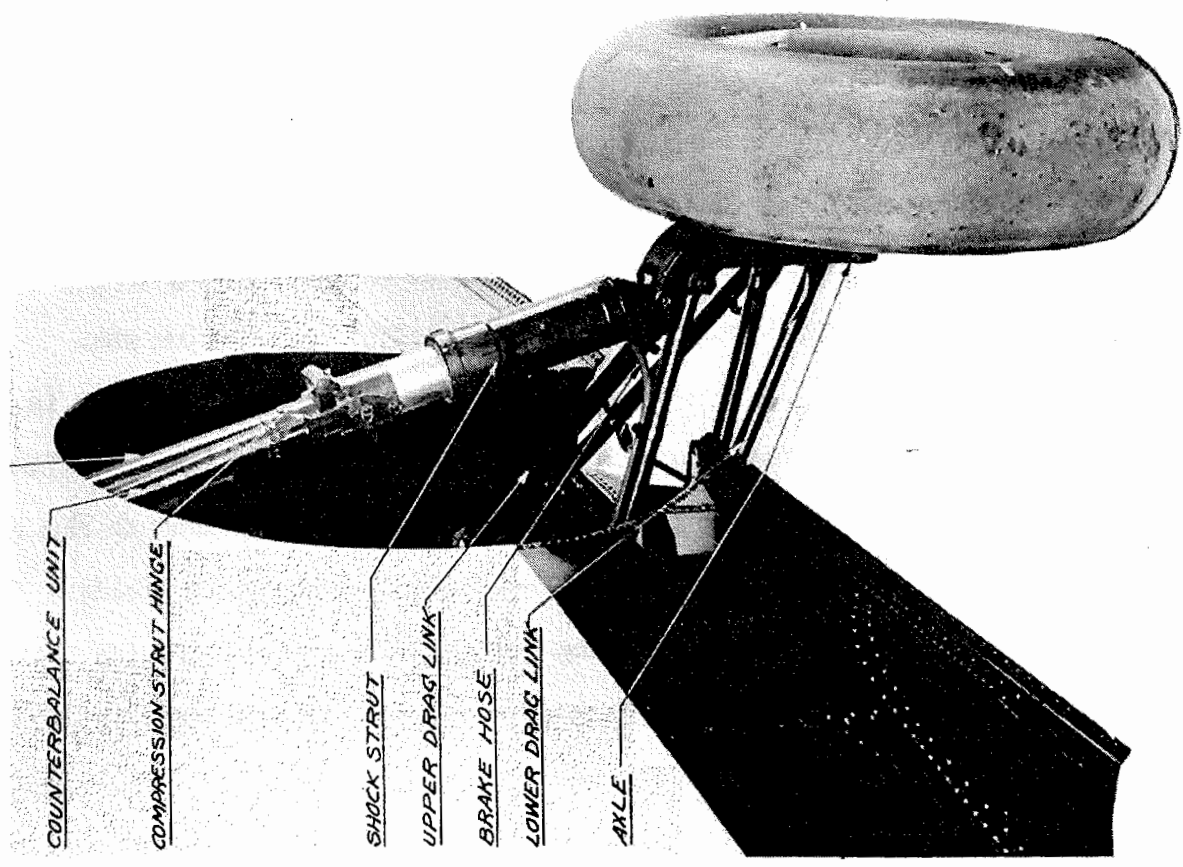

LANDING GEAR WHEELS DOWN

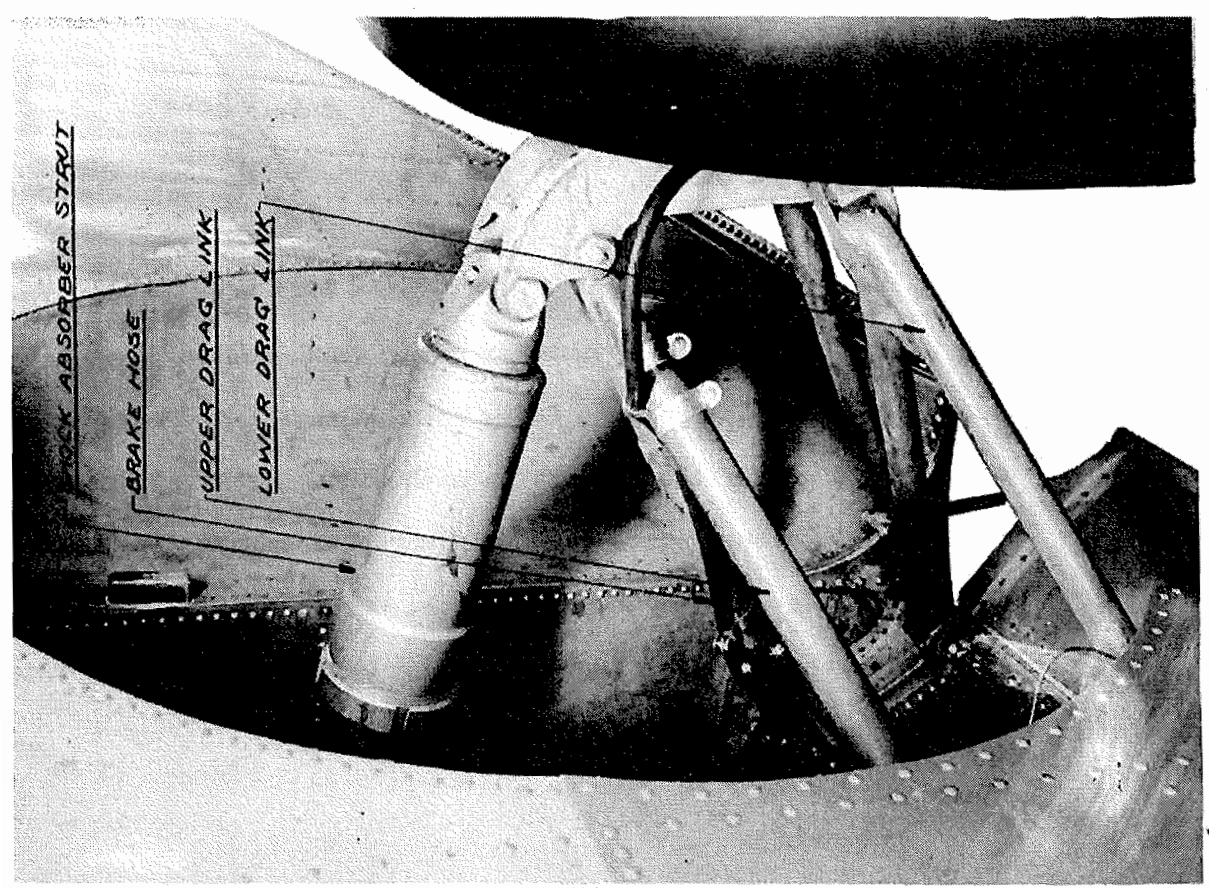

A LANDING GEAR WHEELS PARTIALLY RAISED.

Fig 7

Function

This type strut is a combined hydraulic and pneumatic type. Impact loads are dissipated largely through the hydraulic unit by forcing fluid through an orifice. Taxiing loads are absorbed mainly by the compression of the air.

When the load comes on the strut, the fluid below the piston is forced through the orifice in the piston, past the metering pin, into the upper chamber, where the rising fluid level compresses the air above it. When the strut has made a sufficient stroke to absorb the energy of the impact, the air in the top (which has been compressed to give three load factors if the stroke is the full stroke) expands and forces the oil back.

Filling

The fluid used in this strut is a mixture of castor oil and alcohol, standard #5 Lockheed fluid obtainable at any Hydraulic Brake service station may be used for refilling. As an emergency, a mixture of equal parts of castor oil and high boiling point alcohol may be used for refilling.

To check fluid level: - Let out all air and, if ship is not resting on wheels, jack up wheels until shock struts are fully compressed. Remove filler plug and add fluid until no more will go in. If much fluid is required to fill, move wheels slowly up and down several times thru the full stroke of the oleo strut to remove air pockets. It is not necessary to disconnect oleos from ship for this operation but if done on the bench, the struts should be fully compressed in about the normal vertical position: - otherwise too much oil can be added.

Inflation

Air pressure $450\frac{#}{sq.in.}$ is required to inflate these struts under full load. This is obtained with the Bendix Booster Hand Pump attached to the Hangar High Pressure Line of $80\frac{#}{sq.in.}$ to $120\frac{#}{sq.in.}$. One man can with ordinary effort boost the pressure to the maximum required. If he cannot do this, there is a leak somewhere in the line, the pump valves, or the connections. If no pressure line is available, connect an ordinary tire pump to the booster pump.

Main Strut

For the main landing gear strut, air should be added until the distance between the filler plug center line and the top of the cylinder assembly is $4\text{-}7/16"$ under full load. This will bring the piston to a point which is in the middle of the 6" stroke of this strut. For first inflation, the distance should be approximately $1/4"$ greater, as moving the airplane around will cause some absorption of air by the fluid. A variation of $1/4"$ either way from the $4\text{-}7/16"$ dimension for check readings should not be considered of importance. Adjustments should be made with the airplane out of the wind and without the slip stream from the propellers.

Packing

The packing used on these struts is designated "Johns-Mansville Special Aircraft Packing". The packing nut should be tightened down firmly. In the case of leaks around the outside of the packing the pressure on the nut should be increased. In the case of a leak around the inside of the packing when it is first put into service, it may be necessary to reduce the pressure slightly. If a leak develops around the inside after a considerable period of service it is probable that tightening of the packing may not stop it, in which case it will be necessary to replace the packing rings.

Packing Replacement

To replace packing, release all air from strut by depressing air valve core. Remove filler plug and pour out about half of the fluid. Put strut in vertical position and back off packing nut completely. Remove complete piston tube assembly with packing and packing nut from the cylinder by pulling upward. This operation will be facilitated if the piston is pushed into the cylinder a short distance and then jerked upward against the packing. After the piston tube assembly has been removed, remove piston head by taking out lock screws in the side of the piston and unscrewing the piston head from the piston tube. The packing and packing spacers may then be removed from the piston tube and new ones installed. Pistons should be locked as in original installation. The entire assembly may then be returned to the cylinder, care being used to see that the packing rings are pushed down into the gland without damage to the rings themselves.

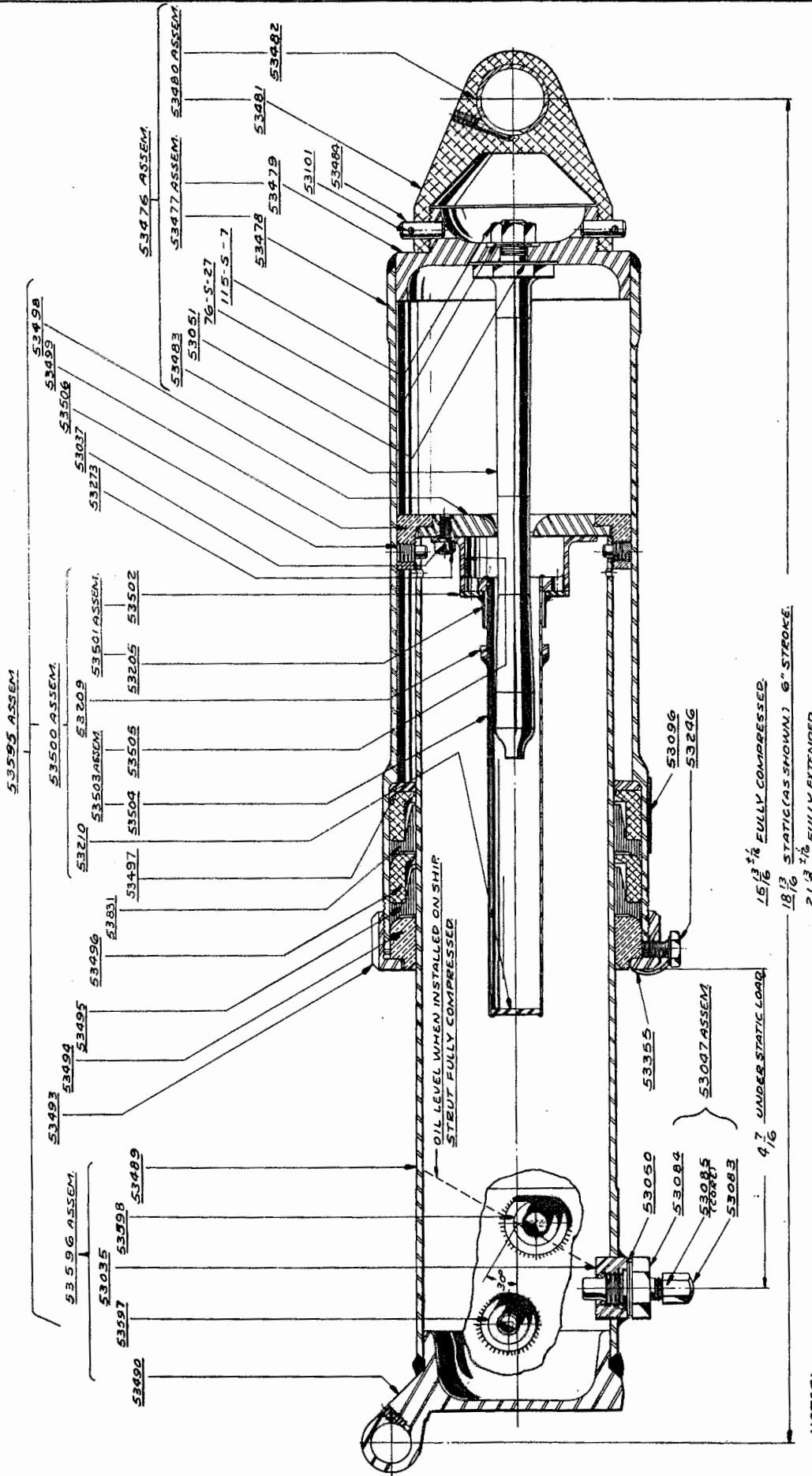

**SHOCK STRUT
LANDING GEAR**

MODEL G21-A
BENDIX # 53590

NOTES:
 ACTUAL WEIGHT FILLED = 14.5 ± 1/8 LBS
 FLUID REQ. FOR COMPLETE FILLING = 2 1/8 PINTS
 APPR. AIR PRESSURE WITH STRUT
 FULLY EXTENDED = 250 LBS. PER SQ. INCH
 PART NUMBERS ARE THOSE OF THE BENDIX
 PRODUCTS CORP. SOUTH BEND, INDIANA, U.S.A.
 53590 2 REQ. PER SHIP

Fig. 8

Tail Wheel Strut

This strut has only 4-1/2" of stroke, but is designed to operate with the piston 1-5/8" above the bottom of the stroke when under full static load. To secure this, the air must be added until the distance from the center line of the filler plug to the top of the cylinder is 2-3/4" under static load. The same remarks regarding variation given for the main strut also apply to the tail wheel strut.

After the struts are once correctly adjusted, readjustment should not be made for minor changes, as this may be due to change in position of airplane, change of load, wind action, packing friction, rolling the airplane backward, etc. Always check only after airplane has been correctly loaded and has been rolled forward with tail down. Do not over-inflate as hard taxiing and bounce at contact will result.

Air Valves

The air valve is incorporated as a part of the filler plug. It operates similar to the standard automobile tire valve, but is of a special heavy construction and provided with rubber which will resist the action of the fluid. Either a Schrader special core or Dill special core developed for this purpose may be used. The cores are interchangeable and replaceable. The hex. cap provided for this type of valve has a soft metal seat to furnish the secondary seal. It should be screwed down tightly.

The valve cores and the seat on the filler plug which is provided with a soft copper gasket should be tested for leaks by putting a little of the shock strut fluid on these joints to show the presence of air bubbles.

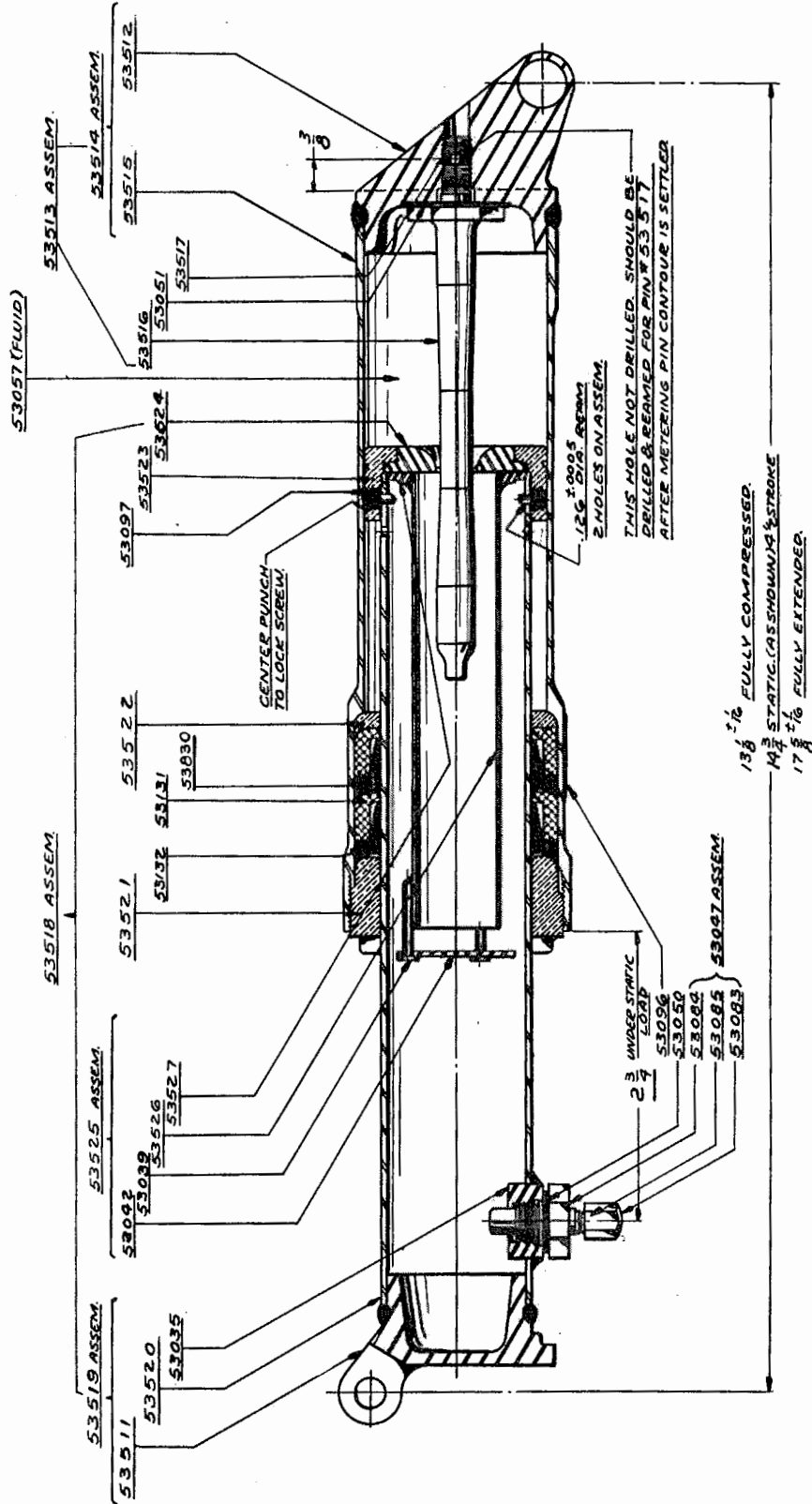

**SHOCK STRUT
TAIL WHEEL
MODEL G21-A
BENDIX # 53973**

NOTES:
METERING PIN # 53516 MUST BE SCREWED DOWN TIGHT IN LOWER END FITTING # 53512 BEFORE LOCK PIN # 53517 IS LOCATED.
METERING PIN # 53516 MUST BE CENTRAL IN ORIFICE WHEN ASSEMBLED.
LOCK PINS # 53097 ARE TO BE LOCATED AFTER PISTON # 53523 IS SCREWED DOWN TIGHT.
ACTUAL WEIGHT FILLED = 6.8"
FLUID REQ. FOR COMPLETE FILLING = 1 1/2 OUNCES
APPROXIMATE AIR PRESSURE WITH STRUT FULLY EXTENDED = 250 P.S.I.
PART NUMBERS ARE THOSE OF THE BENDIX PRODUCTS CORP. SOUTH BEND, INDIANA U.S.A.

(f) Tail Wheel

The tail wheel assembly is the self-aligning full swivel type; fitted with a controllable caster lock mechanism, a special air-oil shock absorber strut and a 13-1/4 dia. pneumatic tire mounted on an aluminum alloy wheel.

With the tail of the airplane supported at the rear hull bulkhead and the fairing removed, the assembly may be installed as a unit to fittings provided.

Locking Mechanism - Shock Strut

When the tail wheel is cranked down to the fully down position, a spring counter-balance automatically comes into action and applies the force necessary to close the strut hinge.

An automatic spring loaded hook type latch locks the strut when closed preventing all possibility of wheel retracting during landing or take-off. No separate control is required for the latch. The latch is automatically disengaged during first increment of motion of retracting control.

Retracting Mechanism

The tail wheel is retracted or extended simultaneously with the landing gear by means of cables (chain over sprocket at rear) attached at forward end to a bell crank (Sta. 13) which in turn is actuated by a push rod connected to another bell crank. This bell crank is operated by a special screw extending aft from the L. G. hand crank unit (see illustration).

In hooking up the tail wheel operating mechanism, synchronization with the landing gear is effected in the following manner:

1. With the landing gear connected up and properly synchronized as described on page 21, wind the hand crank down hard against the stop.
2. With the tail wheel shock strut fully extended, lay the chain and cable over the tail wheel sprocket, and connect the forward turnbuckle. Adjust turnbuckle so that cable is snug without opening the latch at the top of the tail wheel shock strut. This will automatically rotate the top of the sprocket forward, taking up part of the play allowed by the slot in the top of the tail wheel compression link. This slot is provided to allow rotation of the compression link as the shock strut is compressed and extended without rotating the sprocket, and to allow disengagement of latch before opening knuckle.
3. Connect and tighten the rear turnbuckle so as just to take out slack.
4. With the ship hoisted off the ground check the adjustment by raising and lowering the landing gear and tail wheel a few times. When lowering the gear, the tail wheel latch should lock $3/4$ of a turn of the hand crank, before the fully down position.

Swivel Locking Device

A tail wheel lock pin, which locks the tail wheel in the trailing position is provided on this airplane. This pin is controllable from the pilot's cockpit, so that the tail wheel can be locked or unlocked at the will of the pilot.

This pin is operated by a small lever located on the left side of the pilot's instrument board. The "locked" and "unlocked" positions of this lever are plainly marked on the airplane.

The primary purpose of this installation is to eliminate possibility of ground looping in landing, as it is believed that, with the tail wheel locked, any tendency to "ground loop" will be eliminated, except possibly under very unfavorable ground conditions.

Instructions for Use of Tail Wheel Lock Pin

It is recommended that pilots lock the tail wheel immediately after taxiing into position for the "take-off" - but before taking off. The tail wheel will then remain locked during flight and during landing. It may be unlocked by the pilot after the landing run has been completed, in order to facilitate taxiing, or parking on field.

Lubrication

Refer to Tail Wheel Illustration or Lubrication Chart in this manual for points and lubricants used.



SHOCK ABSORBER STRUT

COMPRESSION STRUT HINGE

DRAG LINK

CENTERING SPRINGS

CASTER

5136

A
G2-TAIL WHEEL THREE-QUARTER REAR VIEW Fig. 11

Standard Bendix wheels and hydraulic brakes are used on this airplane. (See illustration for part numbers).

The brake pedals are mounted above the pilot's rudder pedals (on left set of controls only) and move with them.

Adjustment of the rudder pedals automatically adjusts the brake pedals to the proper relative position. In addition, the brake pedals may be adjusted relative to the rudder pedals by adjusting the rod at the lower end of the brake master cylinder.

The rudder pedal adjustment is accomplished by means of a "kick lever" located near the top of the rudder pedal. To bring pedals nearer the seat, hook the toe under the pedal and pull up to position desired. To move pedals forward, depress the "kick lever" and push the pedal unit forward to position desired. There are three positions of adjustment and the three positions of the ratchet can be felt as the pawl clicks in the ratchet.

Parking

The brakes may be locked by means of the "parking" control levers.

Fluid

The fluid used must be of a special type; namely, Lockheed #5, which can be purchased from any automobile supply house. If other fluids are used, rapid deterioration of rubber cups and congealing of fluid at low temperature will result.

Fluid Reservoir

The reservoir is a container holding about two-thirds of a pint of fluid and is at all times open to the atmosphere.

No trouble will be experienced with the maintenance of the hydraulic mechanism if fluid is always kept in the reservoir, at the level indicated on the gage rod.

It is, therefore mounted in a position convenient for inspection and such that the measuring stick attached to its top may be removed to determine the fluid level. (See illustration).

Master Cylinder

The piston is completely immersed in fluid for the reservoir connects to the ports in the main body of the unit. This is to prevent the entrance of air into the line under any condition. The high pressure line is connected to the head end of the cylinder. There is a small port just in front of the piston cup in the off position. This port connects the brake line to the reservoir whenever the brake is in the off position and thus allows the high pressure line to accommodate itself to changes in volume of fluid due to temperature changes, and slight seepage of fluid.

Any air trapped in the hydraulic line is very detrimental to brake operation, because its volume will reduce under increased pressure and thus result in excess pedal travel when operating the brake.

Connecting Means

Flexible lines are used at the master cylinders and at the wheels. Solid lines are constructed of 52S0, 5/16 O.D. x .032 wall aluminum alloy tubing.

The fittings are of the Parker triple compression flared type and so designed that a sleeve is between the tubing flare and the nut.

REPORT NO.1221A

Description of Brake

The Hayes Reversible Hydraulic Brake was primarily designed for use where the airplane has to be held from rolling backwards such as amphibians and for operation on aircraft carriers.

Figure 12a shows the Hayes Reversible Hydraulic Brake.

The brake consists in the main of a torque plate on which a double end hydraulic cylinder is mounted; a one-piece brake shoe; which is located on the torque plate radially and axially by the four adjusting points "A", and a removable fairing. The torque of the brake shoe is taken either thru link "B" or "C" into the torque plate. The links "B" and "C" are pivoted to the brake shoe by pin "D" and their other end is forked straddling pin "E". The links "B" and "C" are identical and shown as "32" on Figure 12b. The brake shoe is retracted by the two springs "42" and "43" thru the Servo control levers "33", which are connected by links to the ends of the brake shoe and thru piston rods to the pistons in the hydraulic cylinder. Spring "42" is painted red and spring "43" is painted black - the black spring being higher tension than the red spring.

As noted in Figure 12a, the red spring should be connected to the Servo Control link which is attached to the toe of the brake shoe - the toe being the one that bears relation to the rotation of the wheels as shown by the arrow in Figure 12a.

Spring "42" on the toe of the shoe is made of lighter tension than spring "43" on the heel of the brake in order that the shoe will always be held in such a manner that there is no clearance between the link "C" and the pin "E" in the torque plate. Therefore, any clearance between the links and the pins which take the torque will be at the toe of the brake because of the red spring "42" having less tension than the black spring "43". Because of this spring arrangement, when the brake is applied with the airplane moving forward, there is no back lash to take up due to shifting of the shoe. However, when the brakes are applied and the airplane is stopped, and it then tends to roll backwards, the entire shoe assembly rotates on the torque plate and the torque is taken thru link "B" on the toe end of the shoe which now becomes the heel. From this it is seen that the brake operates with the same amount of Servo either in the forward or reverse direction, and the only difference between the right and left hand brake is the position of the red and the black spring. The Servo links "33" are the same except for the end where the spring is attached, which is bent up in both cases, making these parts right and left hand.

The rest of this brake is of similar design to the Single Acting Hayes Hydraulic Brake in that the fairing is a separate stamped part and can be removed from the torque plate. This fairing is equipped with four holes with removable covers, thru which the brake clearance can be checked and adjusted by means of the adjusting screws on the torque plate.

The brake cylinder is a separate part and is not part of the torque plate, so it can be removed and replaced if damaged in any way. This cylinder is equipped with the conventional pistons and rubber seal cups held against the pistons by a spring. These parts in their relative positions are shown in Figure 12b.

Installation of Brake

On these amphibian airplanes, the cylinder is mounted at the bottom, so there will be a gap in the shoe where water is apt to collect. This gap will help in drying the brake, and assist in the recovery of the brake after being immersed in water.

When the cylinder is put at the bottom, it is necessary to use special brake cylinders in which the bleeder hole and the fluid connection are reversed so the bleeder hole is again at the top, which means it is towards the axle and the fluid connection hole is away from the axle. All brakes for amphibian use are furnished with this cylinder when specified and otherwise are the same as the standard brake.

When the brakes are installed, a check should be made to make sure that the red spring is on the toe of the brake shoe and the black spring is on the heel. The brakes are marked right and left, so that these springs should be in the right position.

In installing the brakes, it is very important that the proper brake be used on the proper side of the airplane, as the brakes are right and left-hand. The brake assemblies are marked "R" and "L".

After installing the brakes on the landing gear and fastening securely with bolts, it is then only necessary to install the wheel after the Timken bearings have been well lubricated with medium lubricating cup grease.

Excessive grease should not be used but should be worked in the rollers of the bearing carefully. Always see that the felt retaining washers are in good condition so that the grease will not work out from the hub into the brake drum. The greatest care must be used to see that no grease or oil gets on the brake lining.

After the wheel has been installed on the axle, the tongue washer should be installed and the axle nut tightened until the bearings show signs of dragging, after which the nut should be backed off one slot. Before attempting to adjust the bearings, make sure that the brake does not grab, and you can check this through the inspection holes in the torque plate, or by turning the brake adjusting nuts counter-clockwise several turns while revolving the wheel.

Disassembly of Brake

If it is necessary to disassemble the brake for any reason such as removing the brake shoe for relining, or replacing or removing a cylinder to replace the rubber parts, this should be done in the following manner, and can be done in most cases without taking the brake off the landing gear, providing the fairing can be removed so that certain cotter pins on the inside can be removed. However, in general, it is much easier to disassemble and reassemble the brake if it is on the bench where it can readily be worked on.

After the brake has been removed, the fairing can be removed from the torque plate by taking out the nine screws "H". Then pull out the cotter pins "J" which hold the ends of the two springs, after which the washers and springs can be removed. Pull the cotter pins on the inner end of the pins "D" and remove the cotter pins on the end of pins "K". Release all four adjusting bellcranks "A" and remove pins "D" and "K", after which links "B" and "C" can be removed by sliding out thru the slot in the brake band. It will now be possible to throw the links "L" towards the center, which will allow the heel and toe of the shoe to be lifted up, and the entire brake shoe removed from the torque plate.

The brake shoe can now be relined or replaced. If the shoe is relined, the new lining should be cemented to the shoe, by means of "water glass" or sillicate of soda. Of course, it will be necessary to thoroughly clean and paint the shoe if necessary. If the cylinder is to be removed, it is only necessary to remove the nuts from the two clevis bolts "G" and remove the two cap screws holding the cylinder to the torque plate, after which the entire assembly can be removed.

If for any reason it becomes necessary to remove only the brake cylinder assembly, this can be done by removing the two pins "M" and the two cap screws holding the cylinder to the torque plate. It will not be necessary to remove the springs or any of the other parts on the brake shoe as the cylinder can be removed without disturbing these parts.

Assembly and Adjustment of Brake

The brake should be assembled in the following manner, assuming that both the cylinder assembly and brake shoe assembly are off the torque plate.

Figure 12b shows the brake disassembled and the numbers on this figure are the code numbers on the parts list accompanying these instructions.

Before assembling, the cylinder should be washed with alcohol and the pistons and cups lubricated with castor oil or hydraulic brake fluid. DO NOT USE ANY MINERAL OIL SUCH AS LUBRICATING OIL. The cylinder should be assembled with spring "17" between the cups "16". The pistons "15" can then be installed and the rubber boots "19" put on each end, which will hold the pistons, cups, etc. in the cylinder. The brake shoe should be assembled, assuming, of course, that the lining is properly attached to the shoe, by attaching to both ends of the brake shoe, the assembly "34" in Figure 12b by means of pin "K". When attaching the Servo control lever to the end of the shoe, make sure that the proper levers are used on their proper end, so the spring attaching end is bent up to clear the torque plate. A small amount of high temperature grease should be used on all the pins. If pins "E" have been removed from the torque plate, these can be put in the torque plate and properly cotted.

REPORT NO. 1221A

The shoes with the Servo control levers attached can be installed on the torque plate by first hooking the two guide plates in the slots of the lower bellcranks "A" in Figure 12a, after which the heel and toe of the shoe can be dropped in place. Links "B" in Figure 12a, which are the same as "32" in Figure 12b, can now have their open ends placed around the pins "E" and the other end located so that pin "D" can be put in place and cottered. The bellcranks should now be adjusted out uniformly until there is but little clearance between the bellcranks and the guide plates. The cylinder assembly should have the two piston rods "18" pushed thru the hole in the rubber boots "19" and the cylinder can be put in place and the pins "M" put thru the ends of the piston rods and Servo control lever and properly cottered. The cylinder can then be bolted to the torque plate by means of the two cap screws and these should be safety wired.

All parts are in place now except that springs and the clevis pins "G" which form the pivot points for the Servo control levers. A small amount of grease should be put on the two clevis pins. The red and black springs can now be attached to the Servo control levers, making sure the red spring is on the "toe" and the spring end hooked over the pins "N". Install the washers and cotter pins in their proper places at the anchored end of the springs. It will now be necessary to pull the Servo control links in place so that the clevis pins "G" can be put thru the Servo control lever. There is a provision made on the torque plate so by using a screwdriver between the torque plate and the Servo control levers, the spring can be stretched and the Servo control lever held in such a position that the clevis pins can be put thru the Servo control levers. The washers "38" in Figure 12b should be put on before putting on the castellated nut "37". The castellated nut should be tightened up snugly and THEN BACKED OFF ABOUT ONE-HALF TURN SO AS NOT TO CLAMP THE SERVO CONTROL LEVER TO THE TORQUE PLATE. If nut "37" is tightened down snugly, the brake will not release.

The brake can now be reinstalled on the landing gear if removed, and after the wheel is on, the brake band can be adjusted with the proper clearance by means of the adjusting bellcranks "A". It is also important to check, and when new lining is installed, to chamfer the ends of the brake lining back about $\frac{3}{4}$ " from the end, so as not to have the sharp edge of the shoe in contact with the brake drum. The brake should be adjusted with a radial clearance of between .007 and .010 at all four points thru holes "O" in Figure 12b, and if, for any reason, the pedal travel should be too great, this can be decreased by decreasing the clearance as long as the brake does not drag. In making the radial clearance adjustment, it is suggested that the brake be applied after the preliminary adjustment is made and the adjustment again checked to take care of any spring which might occur in the adjusting bellcrank. It is also desirable to rotate the wheel while checking each point to get an average clearance due to any eccentricity in the brake drum.

In filling the hydraulic system, only genuine brake fluid such as Lockheed #21 or equivalent should be used. DO NOT USE SERVO OIL OR ANY OF THE MINERAL OILS USED IN THE POWER OPERATED HYDRAULIC SYSTEM, unless it is first determined that the brakes are equipped with oil resisting seals, in place of the rubber seals.

DO NOT OPERATE BRAKE WHEN WHEEL IS REMOVED FROM AXLE. If the brake is operated with the wheel removed, it is possible to injure the brake by springing the brake shoe out of shape. If this is done, the brake will not release properly and it will be necessary to replace the shoe or remove the shoe, and round it up, so that it will drop in the brake drum freely without the toe or the heel hitting.

Due to the design of this brake, there are heavier radial loads near the heel anchor point of the brake, and therefore, the lining will wear more rapidly at this point. If excessive wear occurs at this point and no new shoes are available, it is possible to reverse the shoe, letting the toe become the heel, which will give a few more hours of operation before the lining has to be replaced, but this practice is recommended only in case of necessity.

If the Servo control levers are to be replaced for any reason, this can be done by removing pins "F" and "K" and clevis bolt "G". It is not necessary to remove the cylinder on shoe assembly. These levers can be replaced as described above after they are hooked on to the springs.

Bleeding the Lines

Whenever the hydraulic lines connecting the master cylinder to the brake cylinders are disconnected, air will be admitted to the system and the lines must be bled to remove the air. This same condition may develop if the fluid reservoir becomes empty. Air in the line may be determined by action of the brake pedal. If the brake pedal has a spongy action when applying the brake, the cause may be due to air compressing in the system.

There are two fittings to the brake actuating cylinder, that is, the inlet fitting and the bleeder. The bleeder is a needle valve with a cap or dust cover on the end.

To bleed the line, proceed as follows:

Fill the reservoir with Hydraulic shock absorber fluid, (Lockheed #5). During the bleeding operation, it will be necessary to check the fluid level in this reservoir several times, never allowing it to become empty.

Remove the cap screw from the bleeder fitting.

Unscrew the bleeder valve one-half turn.

Prepare a piece of rubber tubing at least 12 inches long and slip one end of the tubing over the end of the bleeder fitting allowing the free end of the tubing to hang in a receptacle.

Operate the brake pedal back and forth slowly which pumps fluid out of the reservoir and through the system. Continue this operation until the fluid from the hose connection on the bleeder is free of air bubbles. At least one pint of fluid must be pumped through the system before all air is removed.

Close bleeder fitting tightly and insert the cap or dust cover.

Check the fluid level in the reservoir adding fluid if necessary.

Caution:

Exercise extreme care in bleeding the brake system. If hose is not used when draining the system, the fluid will run down the side of the brake backing plate and will find its way into the lining. The presence of hydraulic fluid on the brake lining will cause a violent grabbing of the brakes.

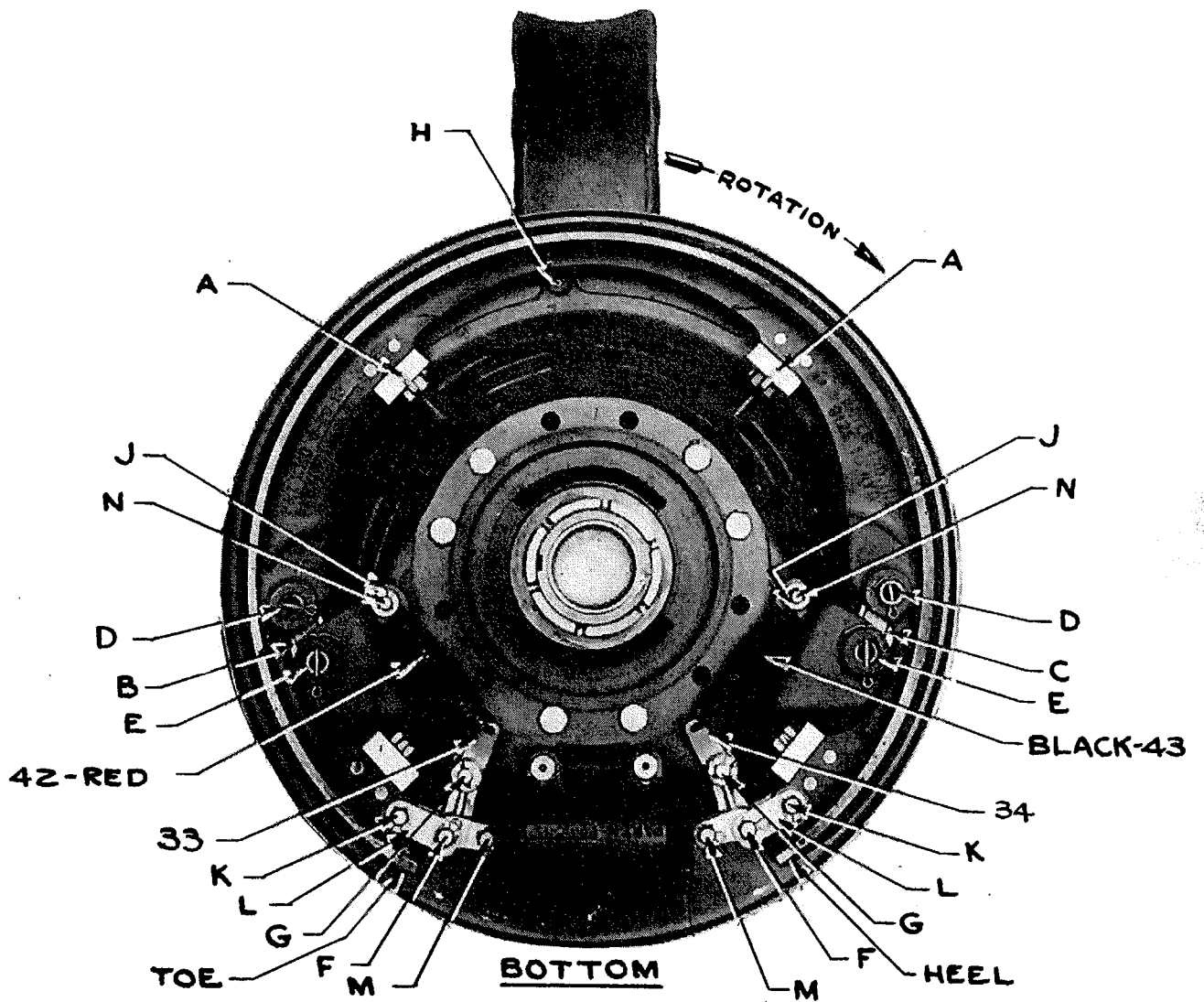

Fig. 12a
R.H. BRAKE

Report
1221A

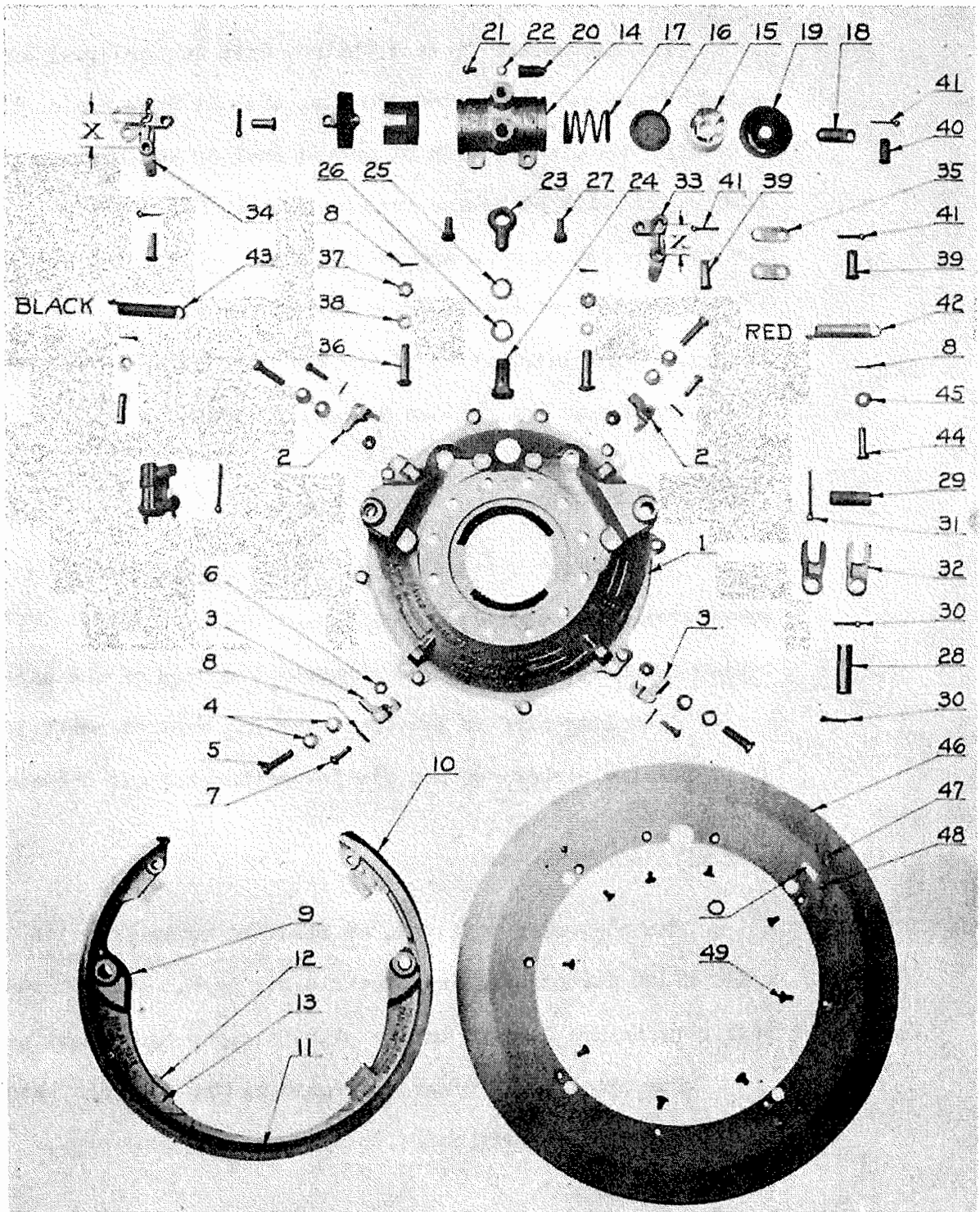

Fig. 12b

BRAKE BREAKDOWN.

(g) Power Plant

The engines are Pratt & Whitney Wasp Junior Model S.B. direct drive radials, rated 450 h.p. each at 2300 r.p.m. for take-off (one minute) with 87 octane fuel or 400 h.p. at 2200 r.p.m. with 80 octane fuel up to 5000 ft. altitude. The recommended maximum engine r.p.m. at cruising is 2000.

For all information relative to the care maintenance, inspection and lubrication of the engines, refer to the Pratt & Whitney Engine Instruction Manual.

Exhaust System

The exhaust system on each engine consists of nine short stacks and clamps, a single manifold unit and a cabin heated assembly. The system exhausts over top of the nacelle.

A cowling muff is provided over the exhaust manifold which permits pick-up of hot air for carburetor air pre-heat.

Starting System

The engines are fitted, as standard equipment with model E-160 direct cranking electric starters. The starter push buttons are located on the pilot's upper instrument panel.

For detailed information regarding the care and maintenance of the starters refer to Eclipse Aviation Corp., instruction manual.

Each engine nacelle is fitted with a large storage battery installed primarily for engine starting (see Electrical System)

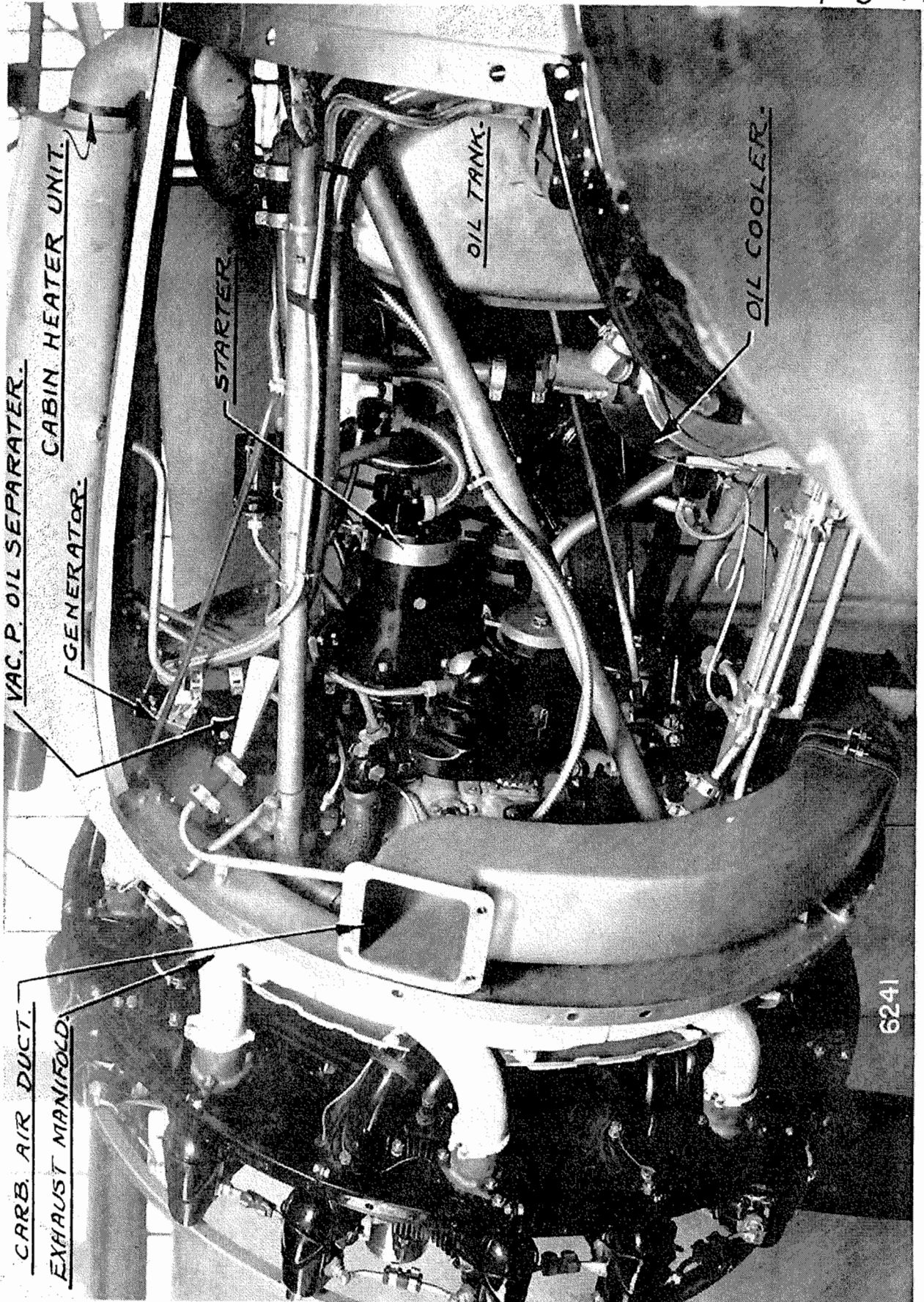

Fig. 13
ENGINE COMPT. ... L.H. SIDE; L.H. NACELLE

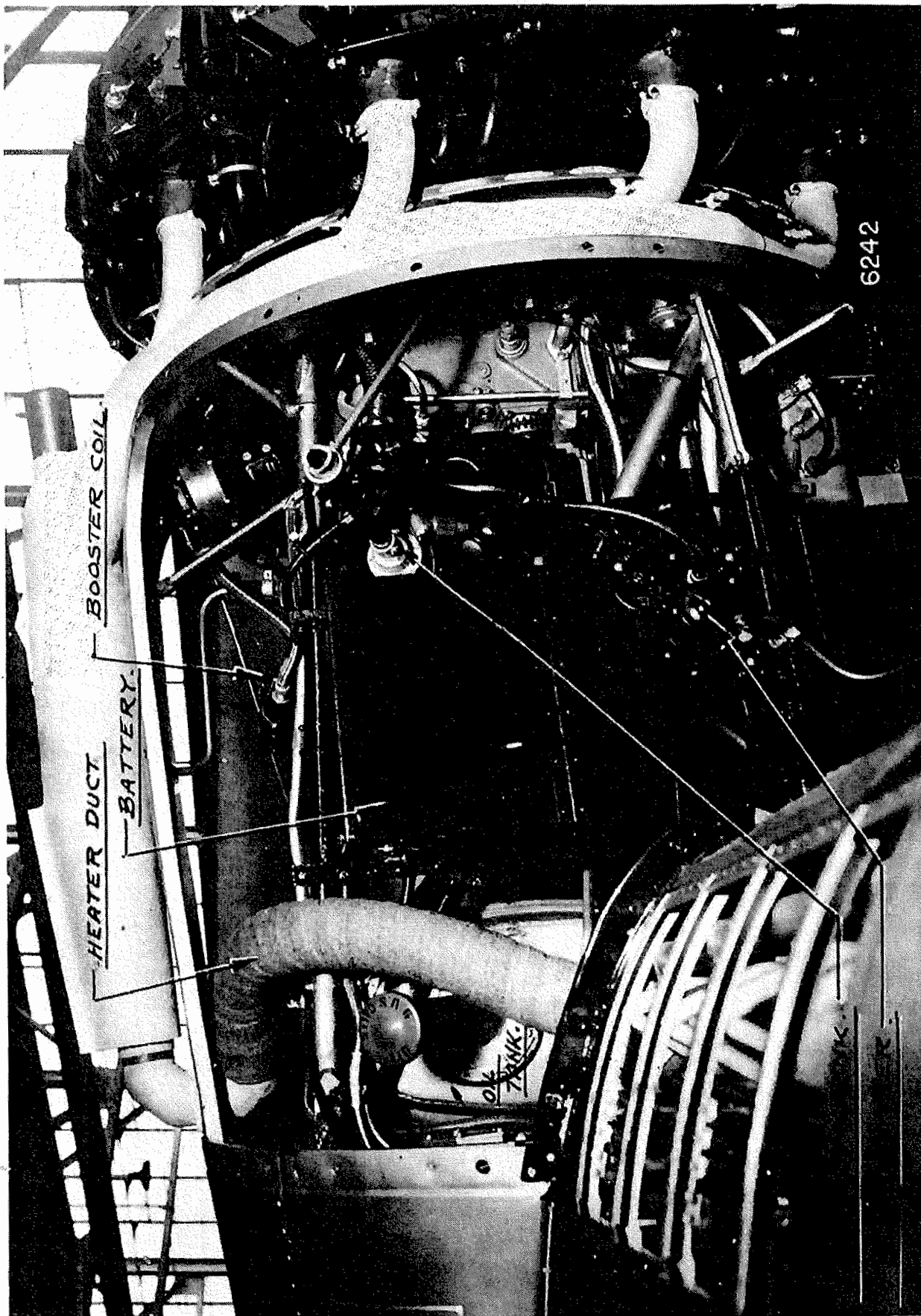
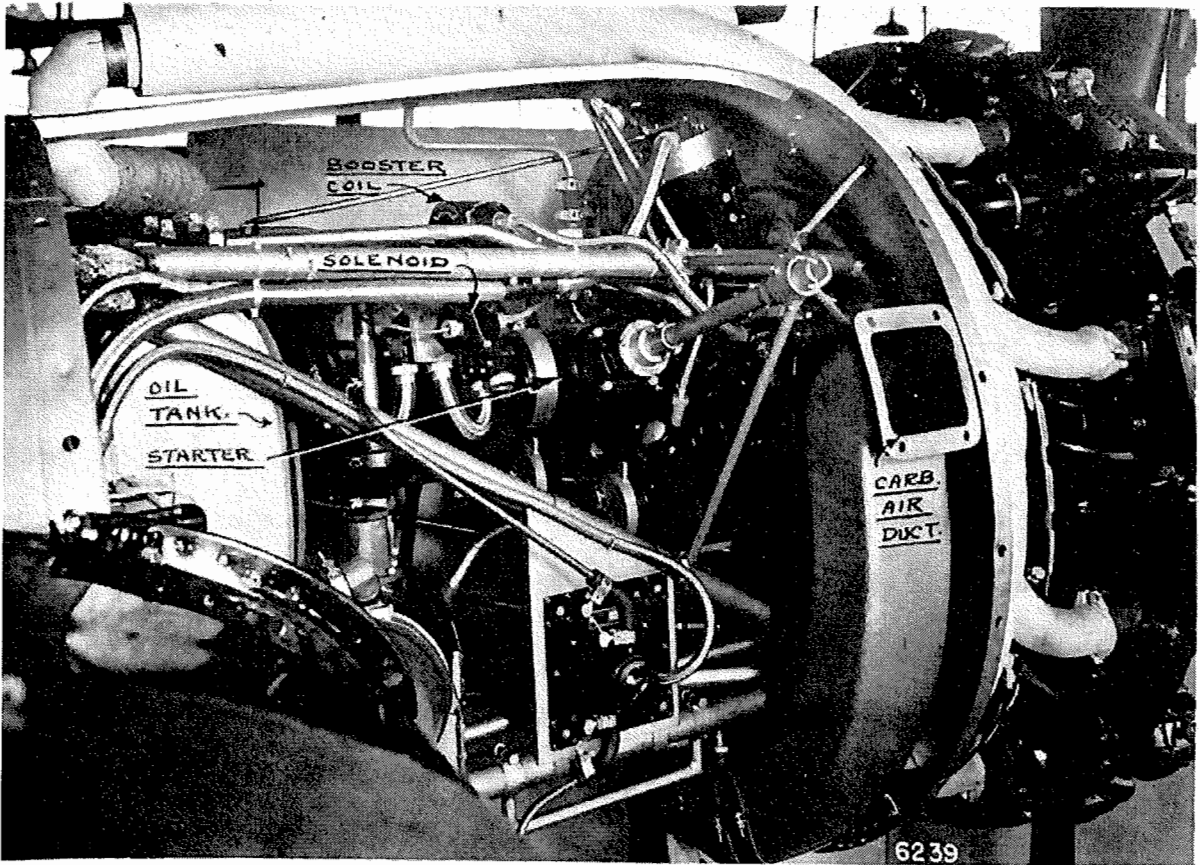
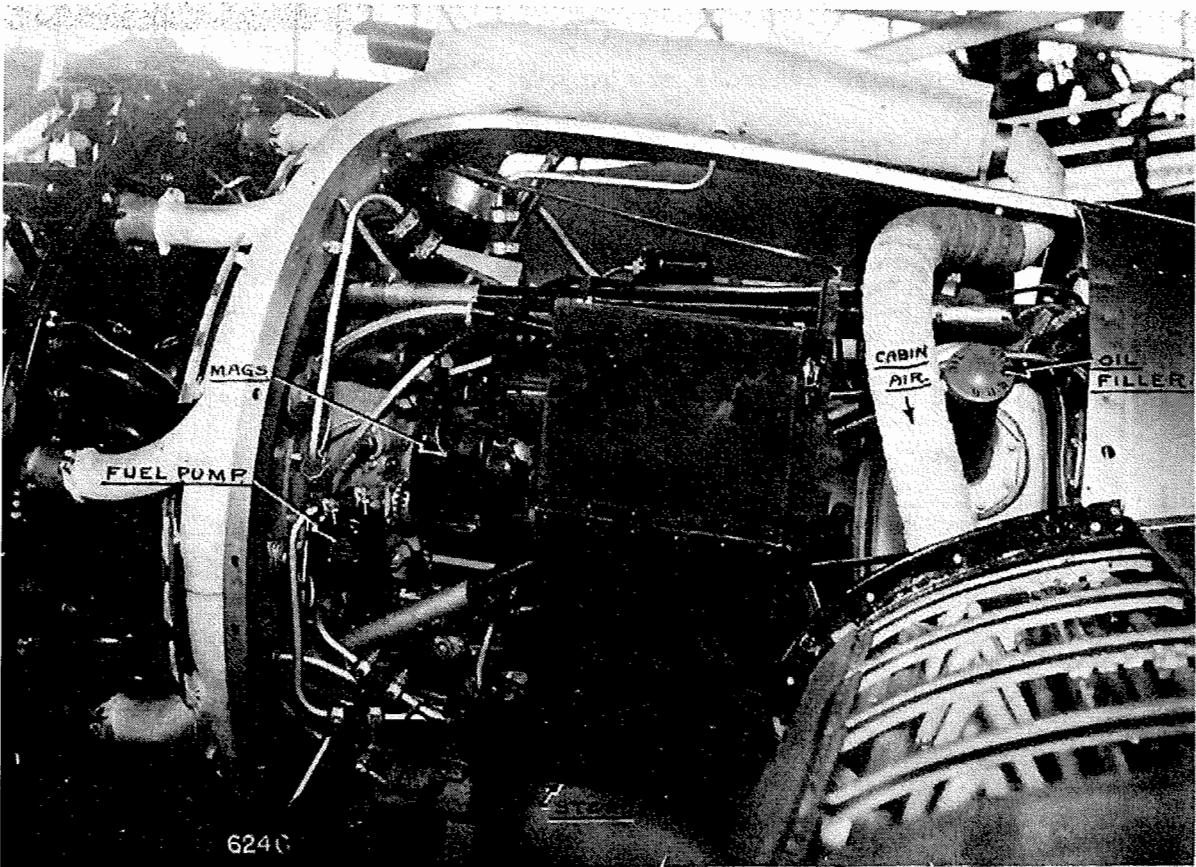

Fig. 13A
ENGINE COMP. ... R.1. SIDE: L.H. NACELLE



ENGINE COMPT. R.H. SIDE OF R.H. NACELLE.



ENGINE COMPT. L.H. SIDE OF R.H. NACELLE.

Fig. 14

Engine Controls

The double unit throttle and mixture control quadrant is located on the pilot's upper instrument panel, and is connected to the carburetors in the engine nacelles by means of a system of push rods and torque tubes. The push rods in the pilot's compartment are of fixed length and connect the quadrant with the torque tubes. The torque tubes run along the wing leading edge from the pilot's compartment to the nacelles.

The push rods in the nacelles are adjustable for length and connect the torque tubes with the carburetor levers.

The wobble pump and fuel valve are operated directly and no special controls are required. The wobble pump and fuel valve are located aft of the pilot on the pilot's compartment rear bulkhead.

The carburetor air intake heater double control unit is located along side the propeller control unit on the upper instrument panel and is connected to the preheat valves by encased push-pull controls. A name plate at the levers clearly indicates the valve position, (down and forward, hot; up and aft, cold). The levers may be operated independently or simultaneously.

Idle Cut-Off

This unit provides for stopping the engines by moving the mixture control levers into the last ten degrees of the mixture segment (lean position).

Priming

The carburetors on the engines of this airplane are a self priming type. Priming is accomplished by placing the mixture control lever in the full lean position; thereafter, working the throttle slowly thru its full travel pumps fuel into several cylinders and the blower section.

Do not overprime, five or six strokes of the throttle lever are adequate for priming at 0° C. (32° F.).

Engine Mount

The engine mounts are constructed of chrome molybdenum steel tubing and each is supported at four points on the wing box beam by large diameter bolts in double shear.

The engine support ring is provided with nine specially welded-on steel housings, shock absorber rubber bushings and pressure plates, comprising a resilient mounting for the engine assembly.

All bolts and nuts shall be carefully checked for tightness at least every 100 flight hours.

CAUTION: Do not tighten the engine ring bolts too tight. Approximately ^{twelve (12)} 10 lbs. on the end of a ~~six~~ inch wrench handle will give the proper tension.

Rubber bushings should occasionally be smeared with castor oil as this preserves the rubber and maintains resilience.

REPORT NO. 1221A

(h) Propeller

The propellers are 8'-6" diameter, two bladed, controllable pitch; manufactured by the Hamilton Standard Propeller Co. Hartford, Conn. (Blade design No. 6095 A-12)

The propellers are controlled by means of push-pull assemblies operated from a double lever unit on the upper instrument panel in the pilot's cockpit. The lever is plainly identified with a name plate, high pitch is up and aft, low pitch is down and forward. The two levers may be operated independently or simultaneously. The left lever controls the port side propeller and the right lever controls the starboard propeller.

For further maintenance information, refer to the Hamilton Standard Propeller Manual.

The correct settings are:

Low pitch - $14 \frac{1}{2}^{\circ}$	} at 42" station
High pitch - $21 \frac{3}{4}^{\circ}$	

(h) Propeller (Cont.)

Constant Speed Propellers:

Constant speed propellers and governors are special equipment. For information regarding their care, maintenance and repair refer to the Hamilton-Standard Propeller Company's Instruction Book.

The propeller is two bladed, 8'-6" diameter. The propeller hub No. is 2D-30, the blade No. is 6095-A-12 and the governor No. is 1A2.

The controls are set so that for take-off the engines turn 2300 r.p.m. with 36.5" Hg. manifold pressure, full throttle.

The normal pitch settings are 12° and 24°, but the propellers, which have basic stops at 9° and 24°, may be set if desired at 10-1/2° low setting to develop 2300 r.p.m. at the blocks and thru out the entire take-off run.

The positive high pitch position of the control lever is up and aft and the positive low pitch position is down and forward.

Intermediate positions of the push-pull handle, control the constant speed (governing) range and any desired r.p.m. can be obtained by properly positioning the control. The selected r.p.m. will be maintained automatically by the constant speed governor for variations in power or altitude of the airplane.

Power is controlled by means of the r.p.m. as well as engine throttle. For any setting of the propeller in the governing position, change of power by movement of the throttle is manifested only by a corresponding change in manifold pressure, not r.p.m., except at very low r.p.m. such as idling.

For take-off, the propeller controls shall be all the way forward (low pitch). This is the point on the controls where 2300 r.p.m. governing will be obtained.

High speed level flight maximum r.p.m. shall be 2200 at 33-1/2" Hg.

Cruising r.p.m. is 2000 at 27" Hg.

(1) Fuel System

The fuel system consists of built-in tanks, fitted with potassium-dicromate crystal screen receptacles, tank outlet strainers, hand fuel pump, two type C-2A fuel strainers, two fuel quantity (boiler gage type) gages, two Pesco engine driven fuel pumps with integral by-pass and relief valves, fuel pressure gages, tank vents and filler caps.

The fuel pressure relief valve is set to maintain a pressure of approximately 4 lbs./sq. in.

Tank Capacities

Each wing tank ----- 110 gals.

Total ----- 220 gals.

Main Fuel Valve

The fuel valve is located on the pilot's compartment rear bulkhead and is reached directly. The five positions are Off - Left Tank - Off - Right Tank - Off. This valve has connections for three tanks, only two of which are ordinarily installed; the third being closed off with a plug nut.

In case it is desired to carry extra fuel in temporary tanks or cans in the cabin, it may be piped directly into the fuel system by connecting to this third outlet by means of tubing or rubber hose.

Engine Cut-Off Valves

These are located just above the wobble pump and may be used to shut off fuel to either engine individually.

Strainers

The C-2A fuel strainers are located on the same bulkhead and are fitted with drain valves and shut-off valves which shall be closed only when draining the strainers. The strainers shall be drained every day before flying.

CAUTION: Lock wire the shut-off valves in the open position after draining.

DRAINING

The tanks may be completely drained by attaching a length of rubber hose to the hose fitting at the strainer drain valve.

When it is necessary to pre-heat the engine or do any flame welding around the engine compartment, the engine should be run "dry" and the carburetor checked to see that it is completely drained.

FILLING

Fuel tanks should be filled before putting ships in hangars. This has two advantages: the danger of explosion due to vapors in the tank is reduced and the chance of moisture condensing in the tank is largely eliminated.

Fuel tanks should not be filled to capacity in cold weather if airplane is to be parked in a warm hangar as the gasoline will expand and overflow through the vents. A fifty degree difference in temperature will cause an expansion of about 2-1/2 gallons per 100 gallons.

The airplane should always be "grounded" before filling the tanks.

Piping, Fillers and Vents

See fuel system diagram herein.

FUEL TANK CRYSTALS

A special screen type receptacle is provided in the bottom of each fuel tank containing commercially pure potassium dichromate crystals, which are procurable at any drug store.

When applied to anodized surfaces such as the interior of the fuel tanks, the dichromate is absorbed in the anodic coating and greatly improves its corrosion resistance.

The receptacles should be removed at three to four month intervals depending on the rate of water precipitation. The crystals are not soluble in gasoline but when water is present they go in solution to the point of saturation giving the water a brownish color. Therefore when clear water can be drained from the tank it is a definite indication that the potassium dichromate is exhausted and requires immediate renewal.

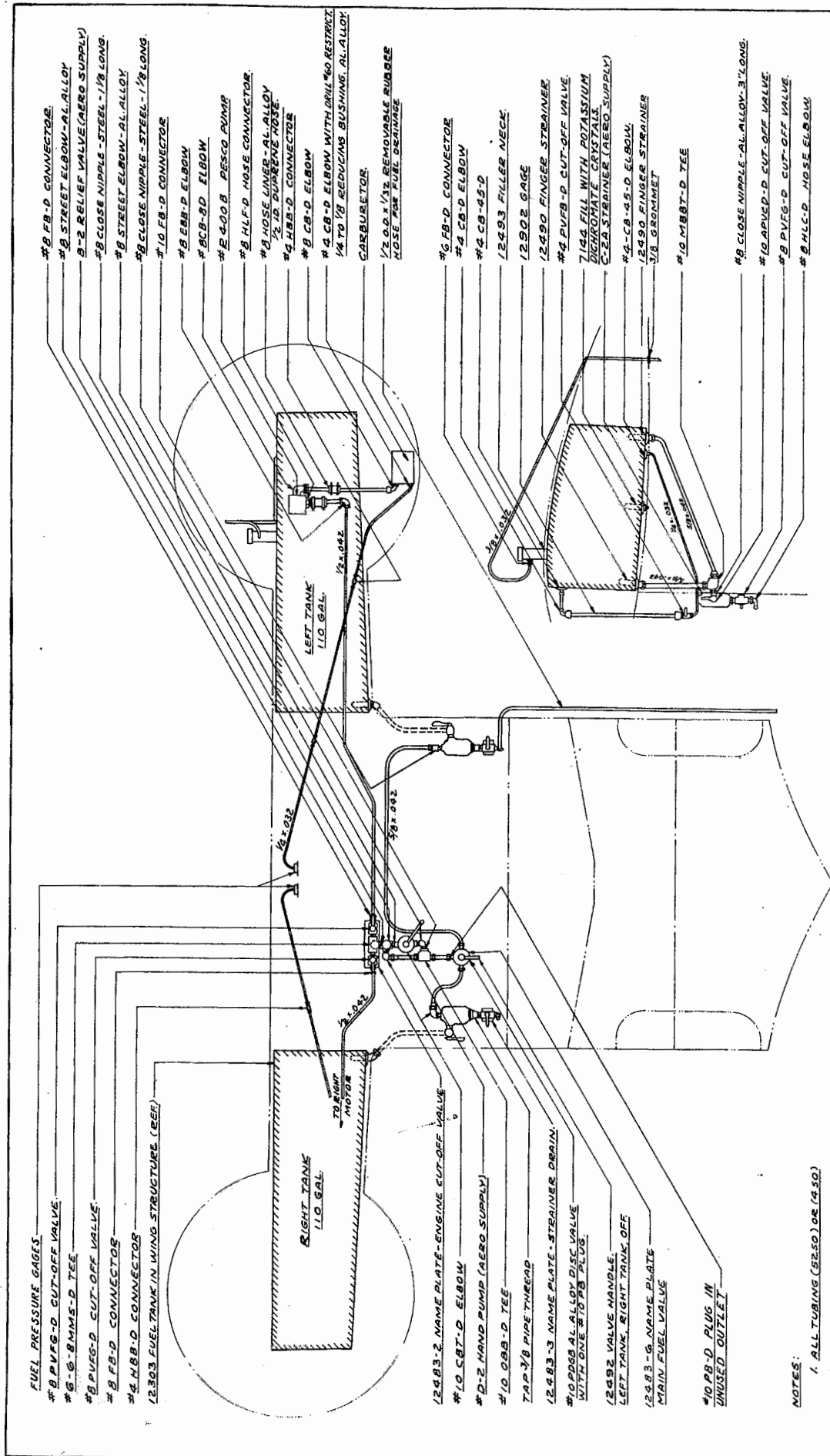

- #8 FB-D CONNECTOR.
- #8 STREET ELBOW-AL.ALLOY
- #2 RELIEF VALVE(AERO SUPPLY)
- #8 CLOSE NIPPLE -STEEL-1/8 LONG.
- #8 STREET ELBOW-AL.ALLOY
- #8 CLOSE NIPPLE-STEEL-1/8 LONG
- #10 FB-D CONNECTOR
- #8 EB-D ELBOW
- #8CB-9D ELBOW
- #E400B PESCO PUMP
- #8 HLF-D HOSE CONNECTOR
- #8 HOSE LINES-AL.ALLOY
- 1/2 ID. DOPRENE HOSE.
- #4 HB-D CONNECTOR
- #8 CB-D ELBOW
- #4 CB-D ELBOW WITH DRILL HO RESTRICT
- 1/4 TO 1/8 REDUCING BUSHINGS, AL.ALLOY
- CARBURETOR
- 1/2 OD X 1/8 REMOVABLE RUBBER
- HOSE FOR FUEL DRAINAGE
- #6 FB-D CONNECTOR
- #4 CB-D ELBOW
- #4 CB-45-D
- 12493 FILLER NECK
- 12902 GAGE
- 12490 FINGER STRAINER
- #4 PVPB-D CUT-OFF VALVE
- 7144 FILL WITH POTASSIUM
- DISSOLVED IN KEROSENE
- C-2A STRAINER (AERO SUPPLY)
- #4-CB-45-D ELBOW
- 12490 FINGER STRAINER
- 3/8 GROMMET
- #10 MB8T-D TEE
- #8 CLOSE NIPPLE-AL.ALLOY-3" LONG
- #10 APVED-D CUT-OFF VALVE
- #8 PVPB-D CUT-OFF VALVE
- #8 HLC-D HOSE ELBOW

- FUEL PRESSURE GAGES
- #8 PVPB-D CUT-OFF VALVE
- #6-G-8MMS-D TEE
- #8 PVPB-D CUT-OFF VALVE
- #8 FB-D CONNECTOR
- #4 HBB-D CONNECTOR
- 12303 FUEL TANK IN WING STRUCTURE (SEE)
- RIGHT TANK 11.0 GAL.
- TO PUMP MOTOR
- 1/2 x .042
- 3/8 x .042
- 1/2 x .042
- 12493-2 NAME PLATE-ENGINE CUT-OFF VALVE
- #10 CBT-D ELBOW
- #D-2 HAND PUMP (AERO SUPPLY)
- #10 CB-D TEE
- TAP-1/8 PIPE THERMO
- 12493-3 NAME PLATE-STRAINER DRAIN
- #10 PDB AL ALLOY DISC VALVE WITH ONE TOP B PLUG.
- 12492 VALVE HANDLE
- LEFT TANK, RIGHT TANK, OFF
- 12493-G NAME PLATE MAIN FUEL VALVE
- #10 PB-D PLUG IN UNUSED OUTLET

NOTES:
 1. ALL TUBING (5250) OR (430)
 2. ALL FITTING NOS. ARE PARKER APPLIANCE CO. NOS. UNLESS OTHER WISE NOTED.

FUEL SYSTEM DIAGRAM MODEL G-21A

Fig. 15

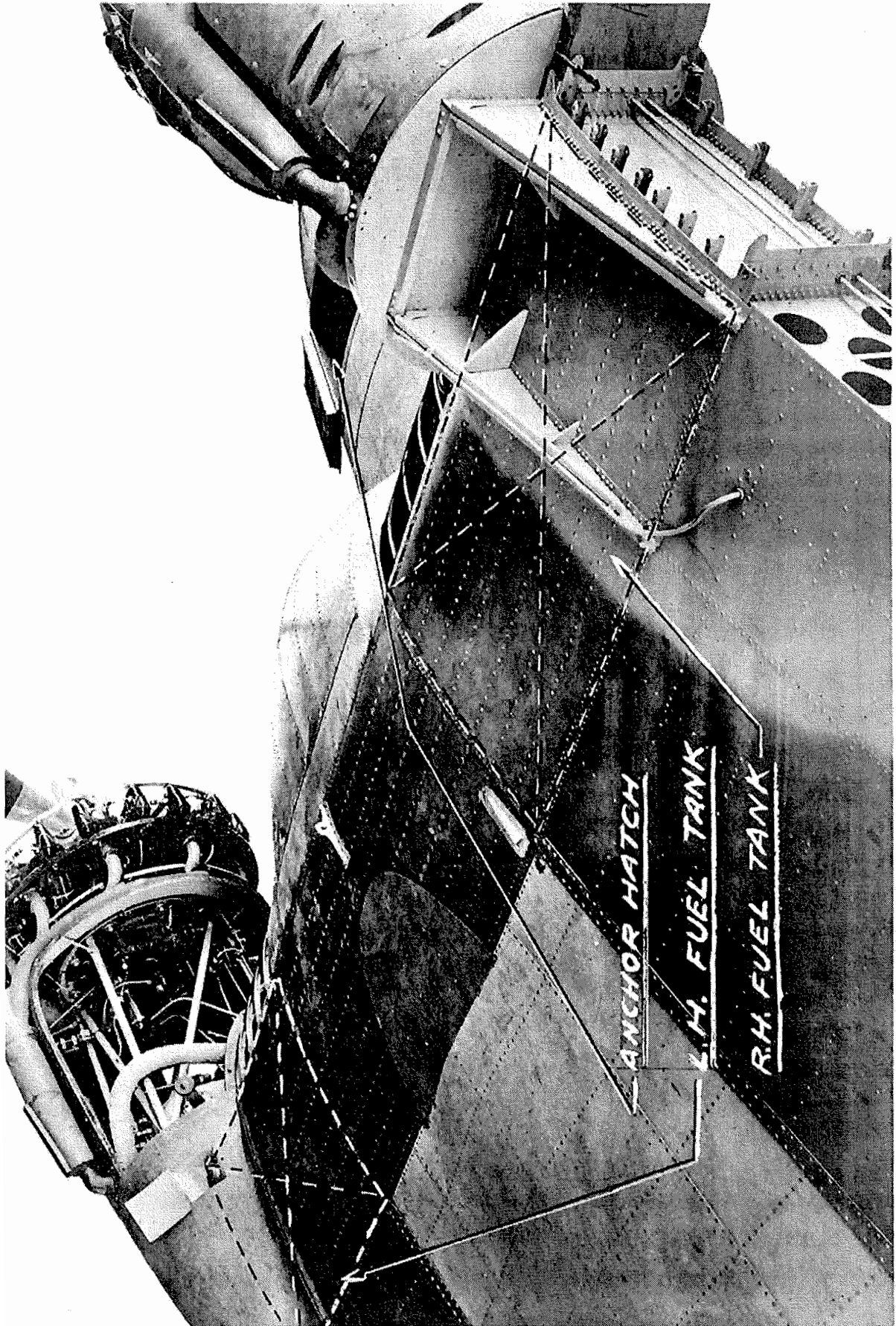

G21A-FUEL TANKS TOP VIEW L.H. & R.H. - Fig 16

(j) Oil System

The oil system for each engine consists of a single tank with oil cooler and ducts, automatic oil temperature regulators, oil lines with flexible connections where required, drain valve, oil pressure and temperature gages.

Oil Tank

The tank is provided with a filler cap having a sounding rod attached thereto and a drain valve with drain tube.

Oil Cooler

The oil cooler is installed in the engine compartment on the engine mount tubes. Air for the cooler enters through a large duct on the outboard side and exits through louvres in the nacelle cowling. The automatic oil temperature regulators are located at the bottom of each tank. They are correctly set at the factory and normally require no attention. If adjustment is required consult engine instruction book for instructions.

Pressure Relief Valve

The oil pressure should be maintained within the limits set by the engine manufacturer and is regulated by adjusting the relief valve on the engine.

Drain Valve

CAUTION:

Check to see that the drain valves are closed and lockwired when filling the tanks.

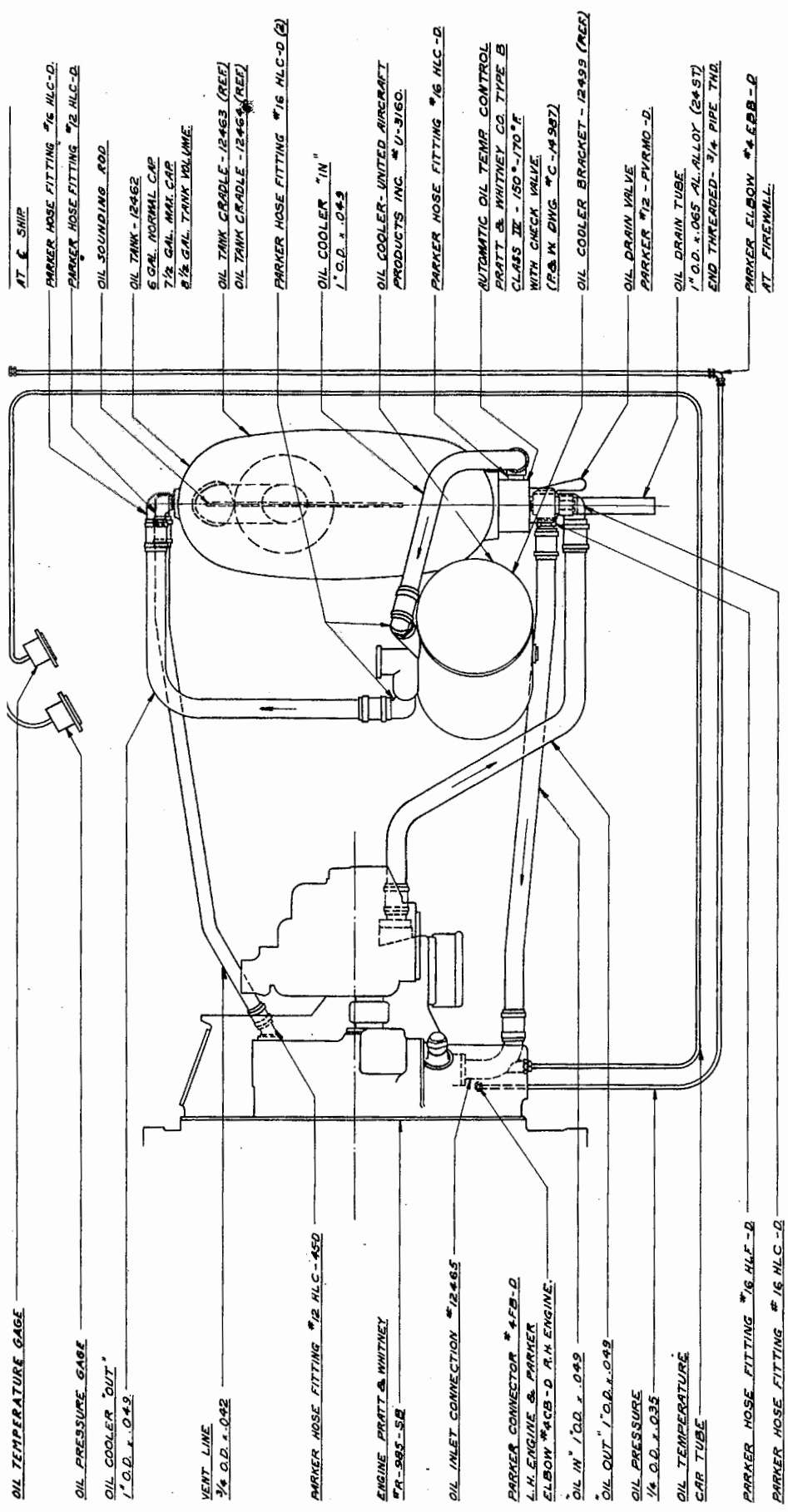

- AT SHIP
- PARKER HOSE FITTING #16 HLC-D
- PARKER HOSE FITTING #12 HLC-D
- OIL SOUNDING ROD
- OIL TANK - 12462
- 6 GAL. NORMAL CAP
- 7 1/2 GAL. MAX. CAP
- 8 1/2 GAL. TANK VOLUME
- OIL TANK CRADLE - 12463 (REF)
- OIL TANK CRADLE - 12464 (REF)
- PARKER HOSE FITTING #16 HLC-D (2)
- OIL COOLER "IN"
- 1" O.D. x .049
- OIL COOLER - UNITED AIRCRAFT PRODUCTS INC. # U-3160
- PARKER HOSE FITTING #16 HLC-D
- AUTOMATIC OIL TEMP. CONTROL PRATT & WHITNEY CO. TYPE B CLASS III - 150°-170°F WITH CHECK VALVE (P&W DIV. # C-14987)
- OIL COOLER BRACKET - 12499 (REF)
- OIL DRAIN VALVE PARKER #12 - PYRMO-D
- OIL DRAIN TUBE
- 1" O.D. x .065 AL. ALLOY (24-57) END THREADED - 3/4 PIPE THD.
- PARKER ELBOW #4-EBB-D AT FIREWALL

- OIL TEMPERATURE GAGE
- OIL PRESSURE GAGE
- OIL COOLER "OUT"
- 1" O.D. x .049
- VENT LINE
- 3/4 O.D. x .042
- PARKER HOSE FITTING #12 HLC-450
- ENGINE PRATT & WHITNEY #R-985-SB
- OIL INLET CONNECTION #12465
- PARKER CONNECTOR #4FB-D L.H. ENGINE & PARKER ELBOW #4CB-D R.H. ENGINE.
- OIL IN" 1" O.D. x .049
- OIL OUT" 1" O.D. x .049
- OIL PRESSURE
- 1/4 O.D. x .035
- OIL TEMPERATURE CAR TUBE
- PARKER HOSE FITTING #16 HLF-D
- PARKER HOSE FITTING #16 HLC-D

NOTES:
 ALL TUBING AL. ALLOY 5250 EXCEPT WHERE OTHERWISE SPECIFIED.
 FLEXIBLE CONNECTIONS ARE OIL HOSE & HOSE CLAMPS.
 TUBING IS BONDED ACROSS HOSE CONNECTIONS.

OIL SYSTEM DIAGRAM			
LET	CHANGE	APPROVED	DATE
✓	TRACED		
LIMIT UNLESS OTHERWISE SPECIFIED			
DRAWN BY	TRACED BY	CHECKED BY	ENG. APP.
W.S.	A.F.M.		
4-21-37	5-20-37		
MODEL		NAVY INSP.	
G-21A		1/2450	
SCALE: NONE		ASSY	
COPYRIGHT			
GRUMMAN AIRCRAFT ENGINEERING CORP. FARMINGDALE, LONG ISLAND			
			12460
			CHANGE

Fig. 17

(k) Air Intake System

The carburetor air preheat scoop mounted below the "up-draft" carburetor is fitted with a valve arrangement, consisting of two interconnected valves and levers, is controllable from the lever unit on the upper instrument panel by a push-pull assembly.

The hot air is taken directly from the exhaust manifold muff and the cold air is supplied from a point on the outboard side of the nacelle through a large duct or conduit to the pre-heat valve.

The design is such that hot or cold air or any desired mixture of both may be supplied to the carburetor. An air temperature thermometer bulb is located in each scoop and the indicators are located on the upper instrument panels.

(1) Fire Extinguisher

A twin engine CO₂ pressure fire extinguisher system is installed in this airplane. The cylinder is installed just forward of the pilot's compartment on the right hand side. The control handle and selector valve are located on the main instrument panel just to the right side of the center line.

The CO₂ charge in the cylinder is 5 lbs.

See diagram herein for piping, fittings and relative location of units.

The cylinder should be removed and weighed every six months in accordance with the instruction placard mounted on the cylinder.

NOTE:

All insurance companies allow a considerable reduction in rates for fire insurance when this system is installed. Be sure to mention when applying for insurance.

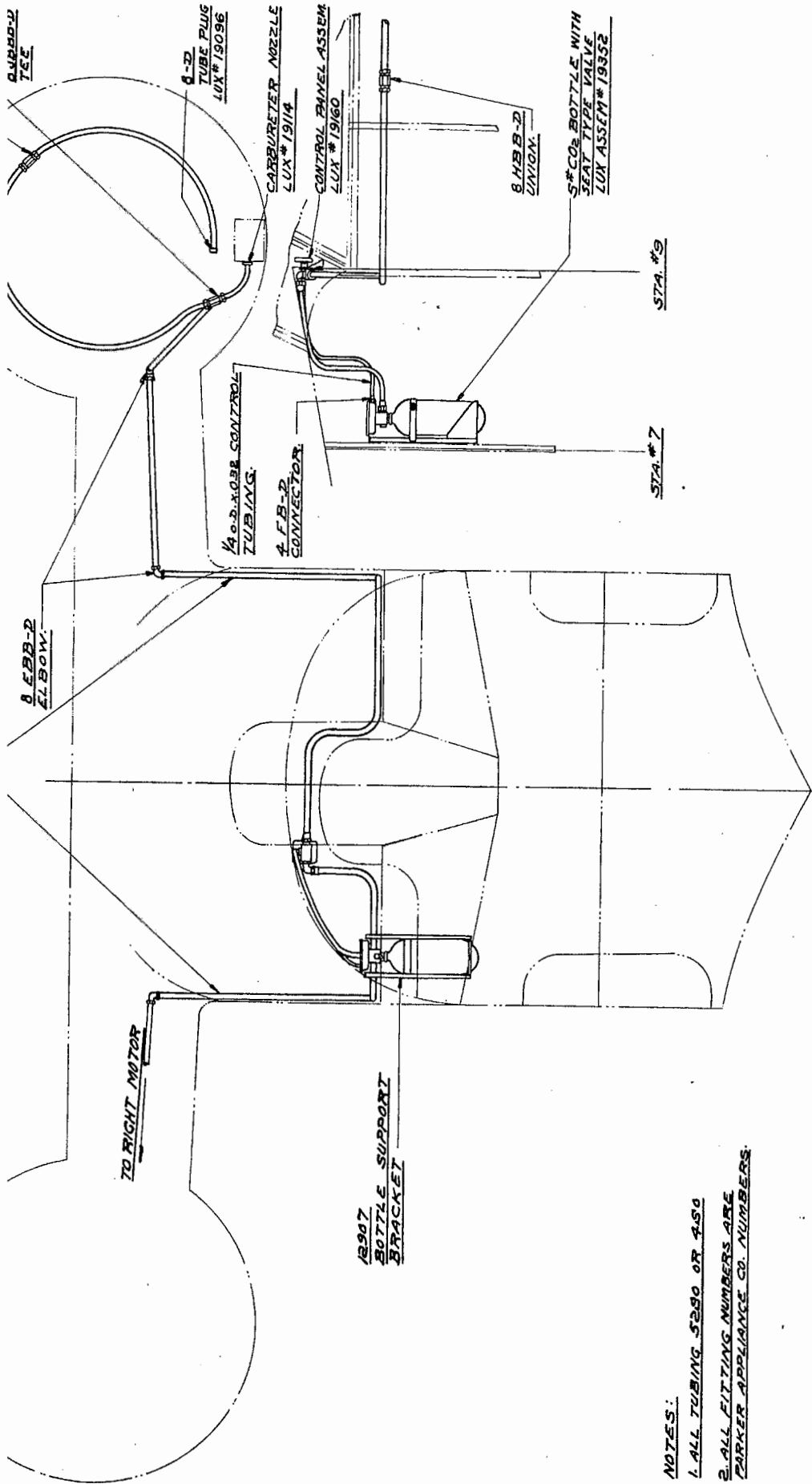

- NOTES:
1. ALL TUBING 5280 OR 450
 2. ALL FITTING NUMBERS ARE PARKER APPLIANCE CO. NUMBERS.

FIRE EXTINGUISHER SYSTEM
MODEL G-21A

Fig. 18

(m) Electrical System

The electrical system is installed in accordance with wiring diagram herein.

The switch box is located on the main instrument panel and contains the exterior light switches, two rheostats and a receptacle.

An electrical distribution panel is located behind the co-pilot and contains the generator switch, two battery switches, volt-ammeter, fuses, spare bulbs and the main junction panel.

One 38 amp. hr. battery is located in each engine nacelle in a suitable container mounted on the inboard side of the structure.

The main instrument board panel contains three instrument lights, one for the compass, one for the gyro* and one for the landing gear warning red jewel.

The upper instrument panel contains the two starter switches, one spot light and the double ignition switch.

The landing gear warning light switch, one four post junction box and one six post junction box are mounted above the upper panel.

The left wing contains, one six post junction box in the nacelle, two four post junction boxes, one passing light*, one landing light and one running light.

The right wing contains one five post junction box in the nacelle, one four post junction box, one engine generator, one generator control box on nacelle firewall and one running light.

* If installed.

The body contains two cabin lights, two cabin light switches, a baggage compartment switch and a light, and a running light and anchor light junction box.

The rudder contains the anchor light (on top) and the running light (on the trailing edge).

Generator

The generator is a 25 amp. Eclipse type D-1 (on right hand engine).

Landing Light

The landing light is a Grimes retractable type and is located in the left outboard wing panel. The light operation is controlled by a 4 position switch and is operated by an integral electrical motor. The switch positions are "open - light - retract - off (on center)". No manual control is required.

Conduit

All wires are shielded by conduit which is solid aluminum alloy tubing except at special points of connection such as light units where of necessity flexible aluminum alloy shielding conduit is employed. All conduit is connected with standard fittings.

The airplane is completely bonded and shielded for radio.

(n) Instruments

The engine instruments are located on the upper panel and are as follows:

- Two (2) Manifold Pressure Gages
- Two (2) Oil Pressure Gages
- Two (2) Oil Temperature Gages
- Two (2) Carburetor Air Temperature Gages
- Two (2) Fuel Pressure Gages
- Two (2) Tachometers
- Two (2) Cylinder Head Temperature Gages

The fuel gages are located just inboard the wing leading edge, in the pilot's compartment and are the direct reading gage glass type.

The flying instruments are located on the main panel and are as follows:

- One (1) Compass
- One (1) Sensitive Altimeter
- One (1) Airspeed Indicator
- One (1) Turn and Bank Indicator
- One (1) Clock
- One (1) Vertical Speed Indicator

The Volt-Ammeter is located in the switch and fuse box.

A gage for the flap vacuum tank is located on the bulkhead forward of the main panel.

The upper instrument panel also includes panel spot light, propeller controls, carburetor pre-heat control, flap control, engine control quadrant, starter switches and ignition switch assembly.

The main panel also includes the tail wheel caster lock control, the fire extinguisher control, the electrical switch box and the landing gear warning light.

Sufficient room exists on the main panel for additional instruments, not included in "standard equipment".

An additional spot light is mounted on the bulkhead to the rear of the pilot.

Revised 6/15/58

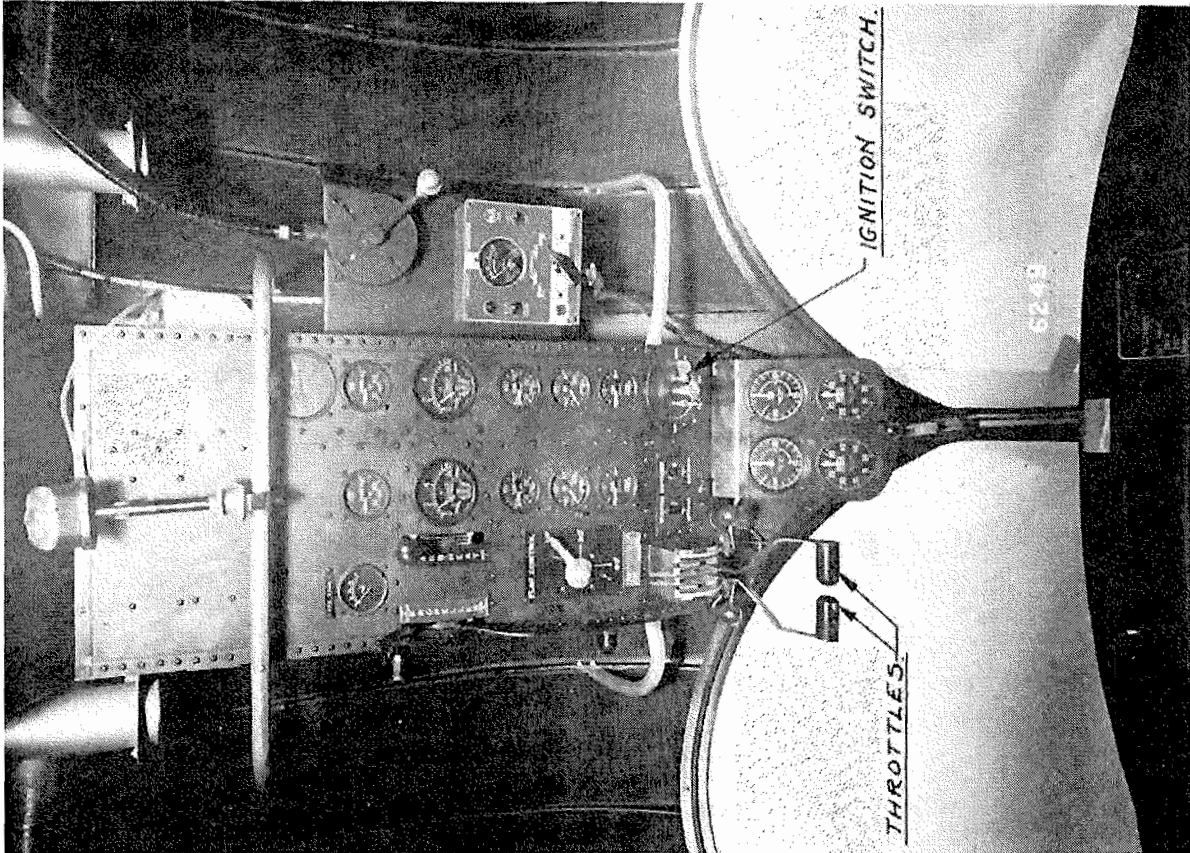

UPPER INSTR. PANEL.

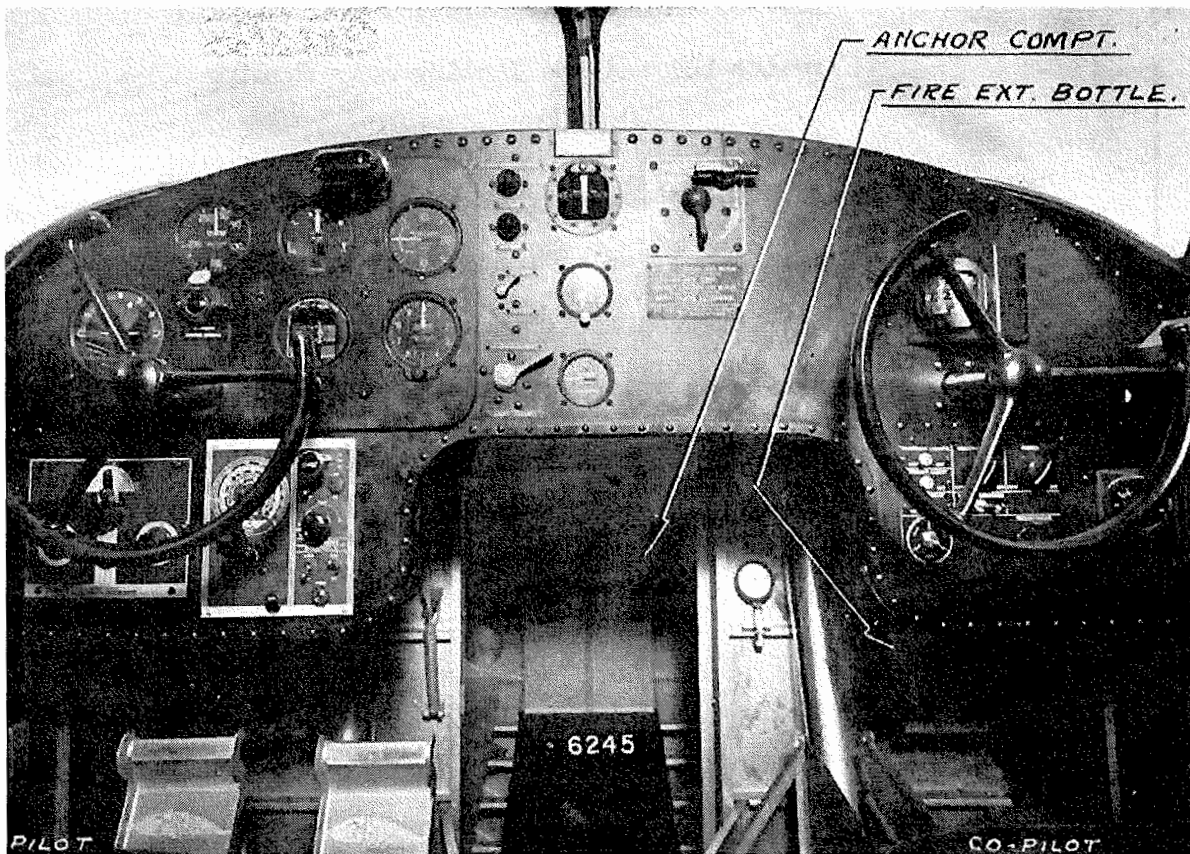

- LOWER -

G21A INSTRUMENT BOARDS Fig. 20

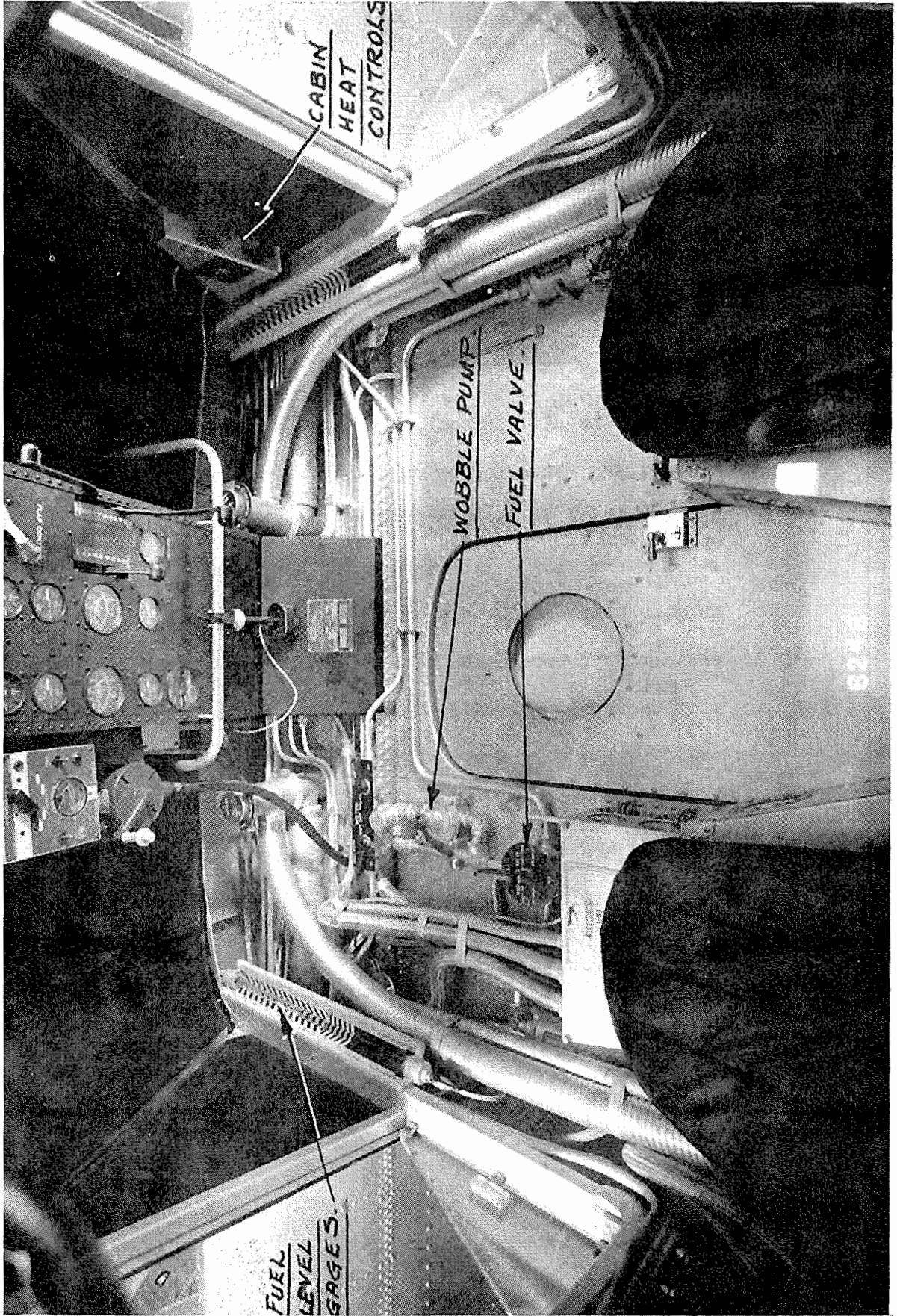

PILOTS COMPARTMENT LOOKG. AFT
Fig. 21

(o) Surface Controls

Aileron Control System

The aileron cockpit control is a dual wheel unit, universally connected by shafts to remote control column located ahead of the main instrument panel. The control columns are fitted with chains and sprockets. Cables running over ball bearing pulleys in the pilot's compartment connect the chains with a central bell crank which in turn operates push-pull tubes located in the wing leading edge. The wing push-pull tubes and bell cranks are fitted with ball bearings. Adjustable push-pull tubes are provided at the aileron horns and are faired with metal covers.

Cables are 5/32 dia., 7 x 19 extra flexible cable.

Rudder Control System

The rudder cockpit control is a dual system of overriding cantilever pedals interconnected by torque tubes. The left set of pedals, which include the brake pedals, are directly connected to the torque tubes while the right hand set float on the torque tubes and actuate the controls indirectly by contact with fixed levers on the torque tubes.

Push-pull tubes connect the pedal unit with a bell crank assembly located under the flooring directly ahead of the pilot's compartment rear bulkhead.

Control from here on to the rudder control horn is by means of $3/16$ dia., 7 x 19 extra flexible cables running over ball bearing pulleys rigidly supported in metal brackets.

The cables are fitted with turnbuckles.

All push rods, bell cranks and pedal joints are fitted with ball bearings.

The pilot's rudder pedals are adjustable to three positions. The adjustment is simple and is readily accomplished by operating the ratchet lever on the outer left pedal with the toe. See Page 36.

The copilot's pedals are not adjustable but may be folded into the floor when not in use.

The rudder pedal stops are under the cockpit floor in the center of the airplane and may be adjusted if required.

Elevator Control System

The elevator control is a dual wheel type. Shafts fitted with universal joints connect each control wheel with the corresponding control column up forward. Special bearings are provided on the instrument panel to support the shafts.

The control columns are interconnected by a large torque tube. A push-pull tube connects the left control column with a bell crank assembly located under the flooring directly ahead of the pilot's compartment rear bulkhead.

The control from here on to the elevator control horns is transmitted by $3/16$ dia., 7 x 19 extra flexible cables running over ball bearing pulleys. The cables are fitted with turnbuckles for adjustment.

All push rods, bell cranks and joints are fitted with grease packed ball bearings.

Stops are provided in the cockpit for the control column, as required.

The co-pilot's wheel shaft, fork end and universal block shall be removed by disconnecting bolts at the forward end, when carrying a passenger in the co-pilot's seat.

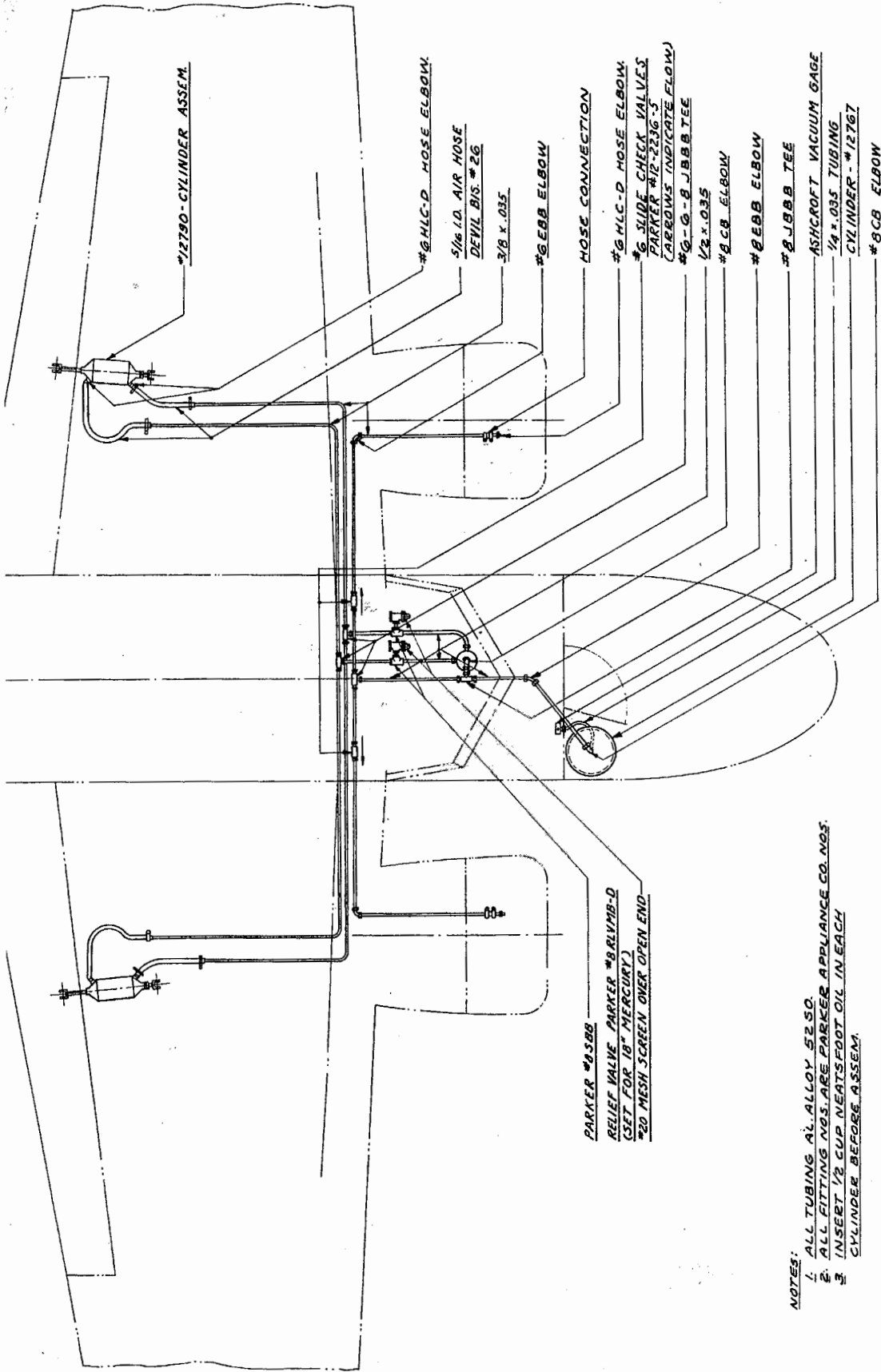

#12790 - CYLINDER ASSEM.

#6 HLC-D HOSE ELBOW

5/16 I.D. AIR HOSE
DEVIL B'S # 26
3/8 X .035

#6 EBB ELBOW

HOSE CONNECTION

#6 HLC-D HOSE ELBOW

#6 SLIDE CHECK VALVES
PARKER #12-2236-3
(ARROWS INDICATE FLOW)

#6-G-8 JBBB TEE

1/2 X .035

#8 CB ELBOW

#8 EBB ELBOW

#8 JBBB TEE

ASHCROFT VACUUM GAGE

1/4 X .035 TUBING

CYLINDER - #12767

#8 CB ELBOW

PARKER #8 JBB
RELIEF VALVE PARKER #8 RLVB-D
(SET FOR 18" MERCURY)
#20 MESH SCREEN OVER OPEN END

- NOTES:
1. ALL TUBING AL. ALLOY 52 SO.
 2. ALL FITTING NOS. ARE PARKER APPLIANCE CO. NOS.
 3. INSERT 1/2 CUP NEATSFOOT OIL IN EACH CYLINDER BEFORE ASSEM.

DIAGRAM
FLAP CONTROL SYSTEM
MODEL G-21A

Fig. 23

Tabs

The elevator trimming tabs are hinged on the upper surface of one elevator and lower surface of the other elevator near the elevator trailing edge and are controllable for longitudinal trimming.

The control mechanism consists of a hand crank located on the right hand side of the pilot's seat, a flexible shaft to a drum under the pilot's floor, cables to a drum at the rear, two flexible shafts and two tab actuators with small push rods.

Rotate hand wheel forward and down to bring nose of airplane down.

The rudder tab is hinged on the right surface near the trailing edge and is controllable for lateral trimming.

The control mechanism consists of a knob on the pilot's left shelf rotative on a vertical shaft, a flexible shaft to a drum under the pilot's floor, cables to a drum at the rear, a flexible shaft, a tab actuator and a small push rod.

Rotate the control knob to the left to turn to the left and right to turn airplane to the right.

Cover plates are provided in the elevators and rudder to permit easy access to the tab actuators.

The tab control stops are located under the cabin floor and are accessible for adjustment as required.

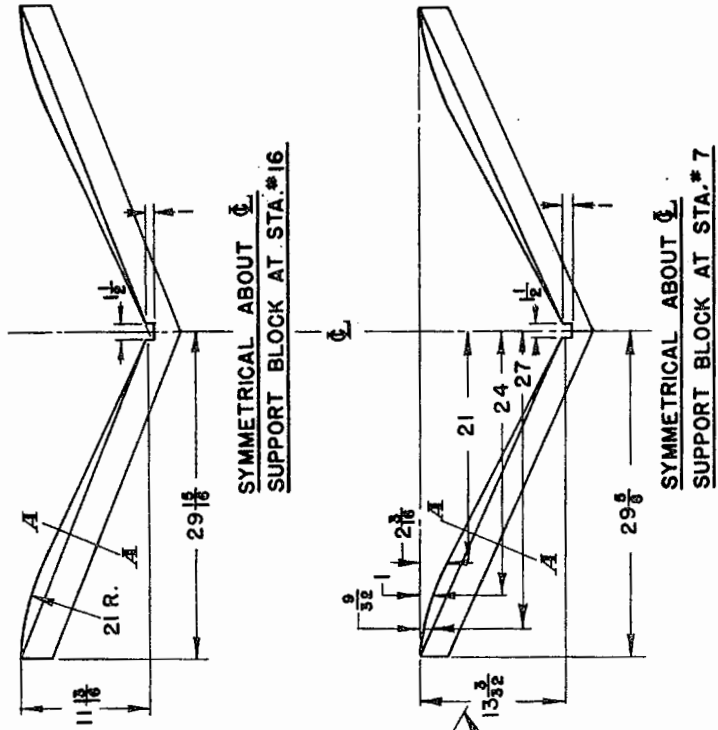

FELT-6" WIDE x 1/2" THICK
NAIL IN PLACE-COVER WITH CANVAS

SECTION A-A

HULL SUPPORTS
MODEL G2I-A

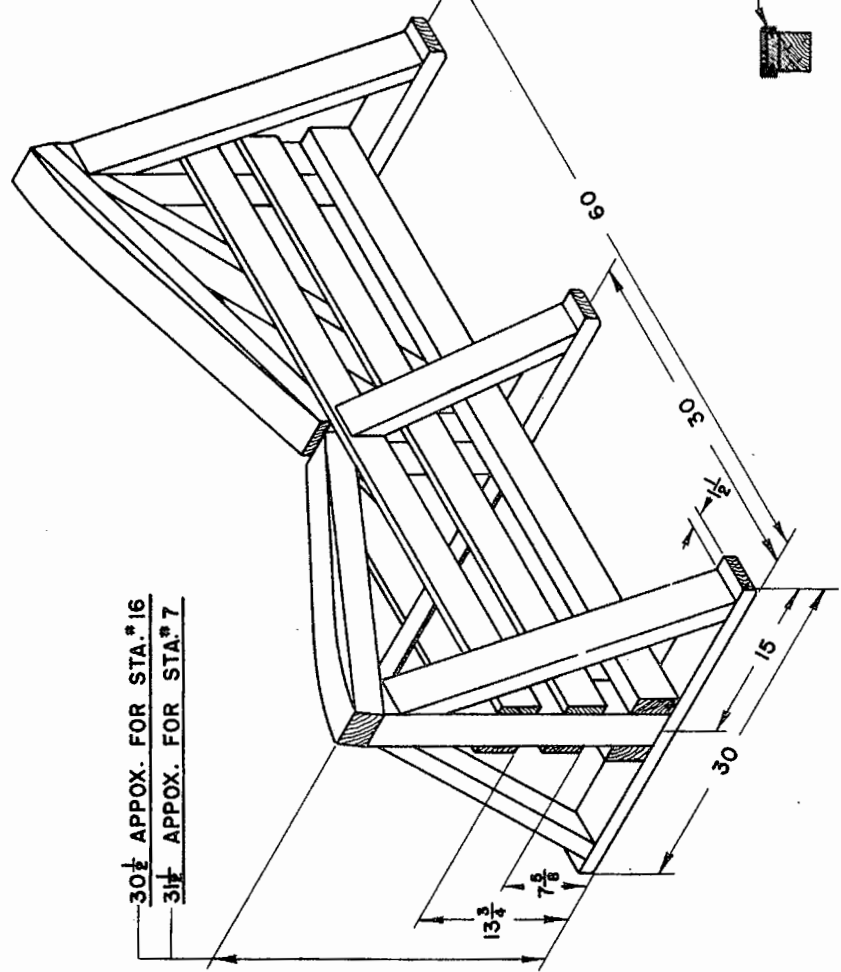

30 1/2" APPOX. FOR STA.#16
31 1/2" APPOX. FOR STA.#7

NOTES:

1. 4 SIDE PIECES 1x4x60 DRESSED SPRUCE.
2. LOW SIDE PIECES, ANGULAR SUPPORTS
8c BASE 2x4 DRESSED FIR.
2. ALL OTHER PIECES 4x4 DRESSED FIR.
2. ALL JOINTS GLUED, AIDED BY #10 FLATHEAD
WOODSCREWS 8c 8 OR 10 PENNY NAILS.
3. SUPPORTS FOR STA.#7 & #16 IDENT., EXCEPT WHERE SHOWN.

(p) Jacking and Hoisting

When it is desired to replace a wheel, the airplane may be jacked up under the axles.

A fitting is provided on top of the wing at the center line for use in hoisting the airplane.

A drawing of the hull supports used at the factory is included herewith. Operators are urged to have a pair built so that adjustment of landing gear and repairs to hull may conveniently be carried out.

These supports are of such size that they may easily be placed under the hull without a hoist. Proceed as follows:

1. With ship resting on wheels, raise tail high enough to place rear support under step - not under false step.
2. Pull tail down far enough to place forward support under Sta. 7 (Approx. 12" ahead of windshield peak).

(q) Towing and Anchoring

The bow of the hull is provided with a chock for use in anchoring the airplane.

A twelve pound stainless steel "Northhill" folding type anchor with 150 feet of 2-1/4 manila line is stowed in the bow compartment. Access to this compartment is either through the bow hatch (double outwardly hinged doors) or through the door leading to the pilot's compartment.

An anchor light is provided at the top of the rudder.

An anchor ring is provided at the tail of the airplane for staking down when on land.

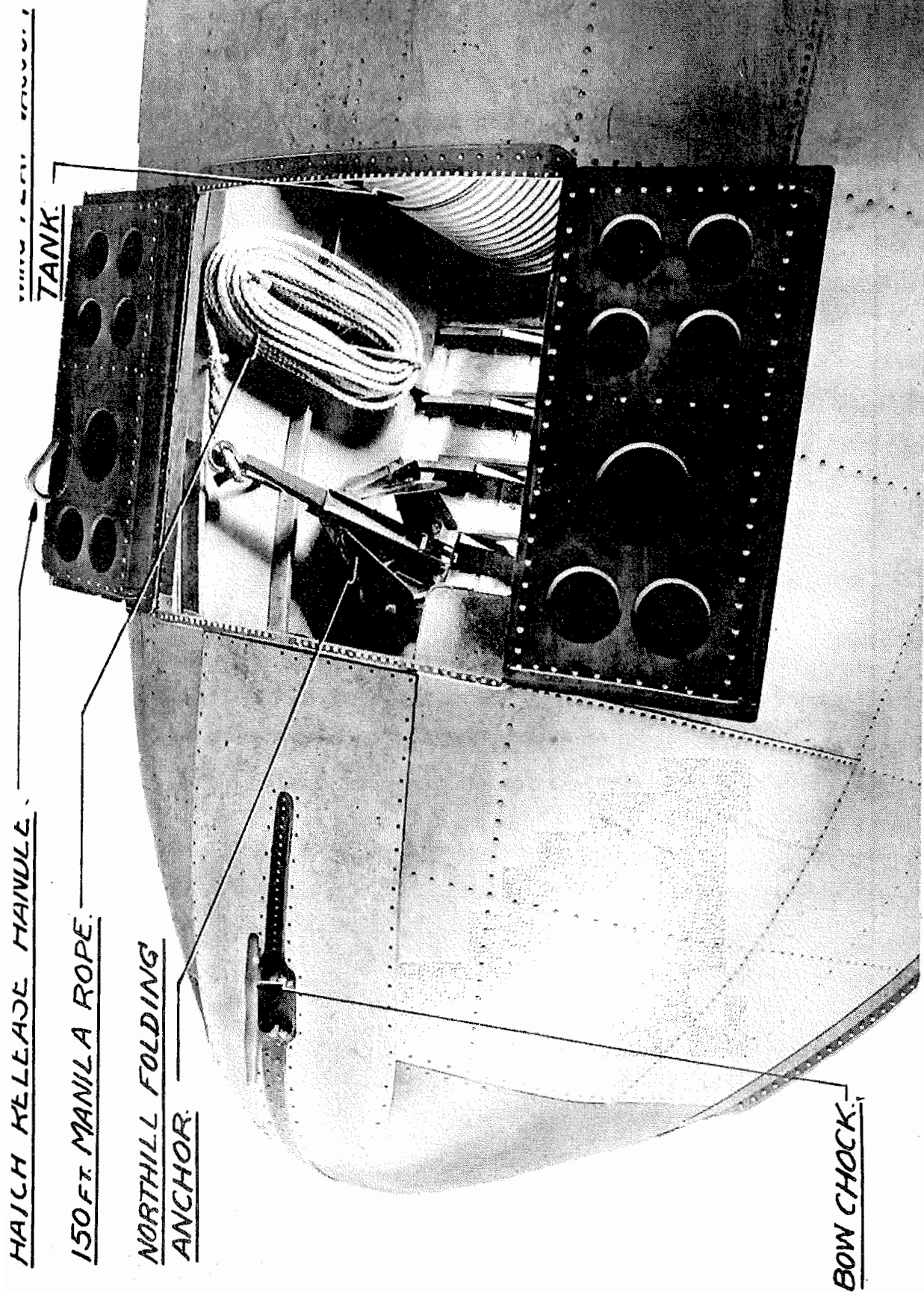

G21A- ANCHOR HATCH - Fig. 24

(r) Ventilating and Heating

The cabin ventilation and heating system consists of an exhaust manifold heat collector tube assembly in each engine nacelle, cold air screened inlet ports in wing leading edge, two remote controllable mixing valves with control handles in pilot's compartment, two directly controlled distributing valves and air ducts to the cabin and cockpit.

The hot and cold air mixing valves are located in the wings and the control handles are on the pilot's side of the cockpit above the side window. The control handles are plainly marked by name plates.

The distributing valves are located at the rear upper portion of the cockpit near the center of the airplane and are directly accessible to the pilots. Operation is as marked on their name plates.

Air outlets are provided at the pilot's feet and at a special diffusing register in the upper front portion of the cabin.

CAUTION:- Heated tubes in exhaust manifolds should be removed and carefully inspected every 40 hours or at least every two months and replaced every 300 hours regardless of condition. These tubes are made of "Inconel", a special material which is the best obtainable for this use, but as they are continuously subjected to hot exhaust blast, their life is limited.

The importance of checking the condition of these tubes at regular short intervals cannot be emphasized too highly as any leak or crack will allow poisonous exhaust gases to be conducted directly to the cabin.

Always purchase replacements direct from REPORT NO. 1221A
the Grumman factory.

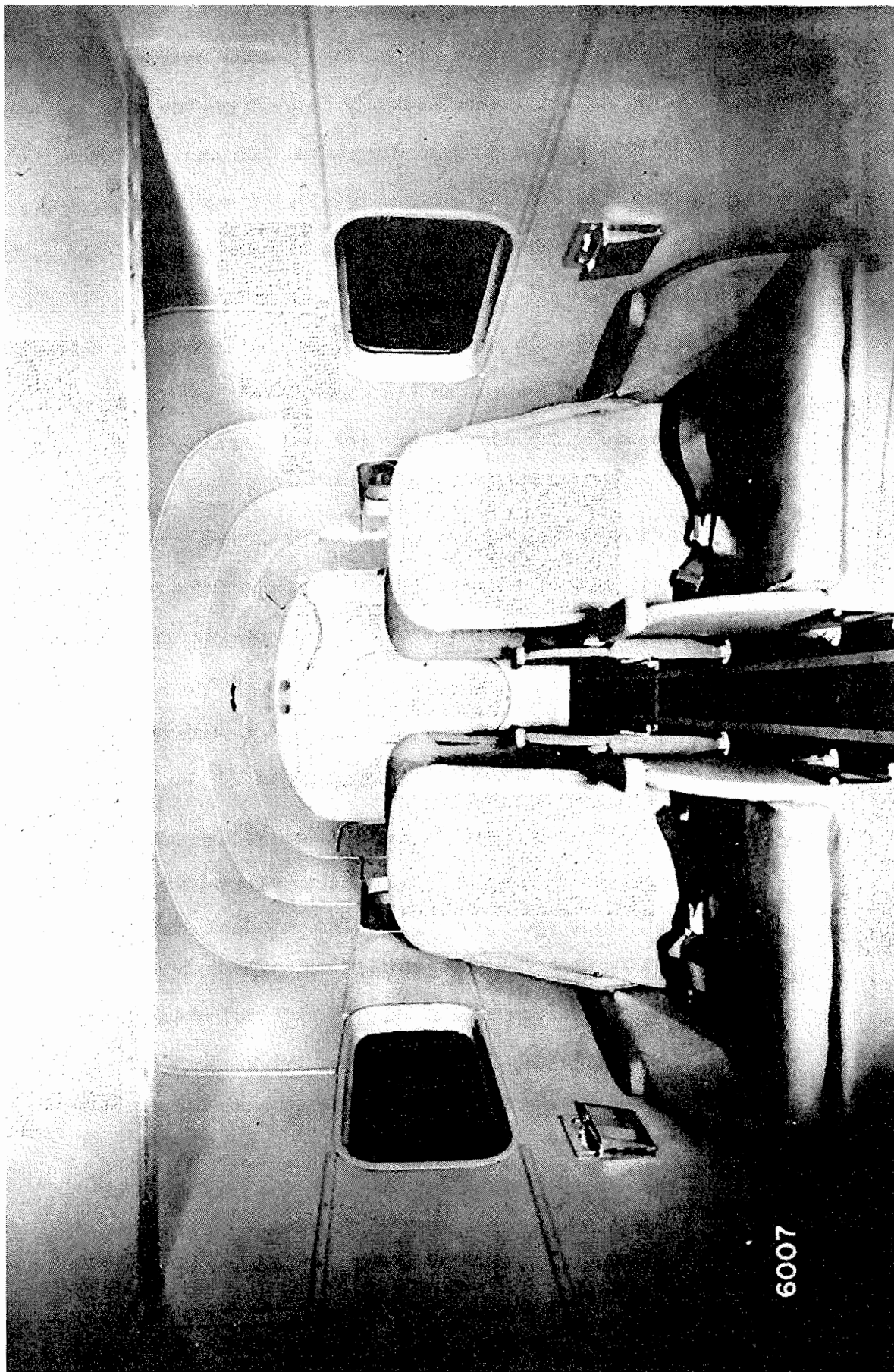

G 21A- CABIN INTERIOR · LOOKING AFT. Fig. 25

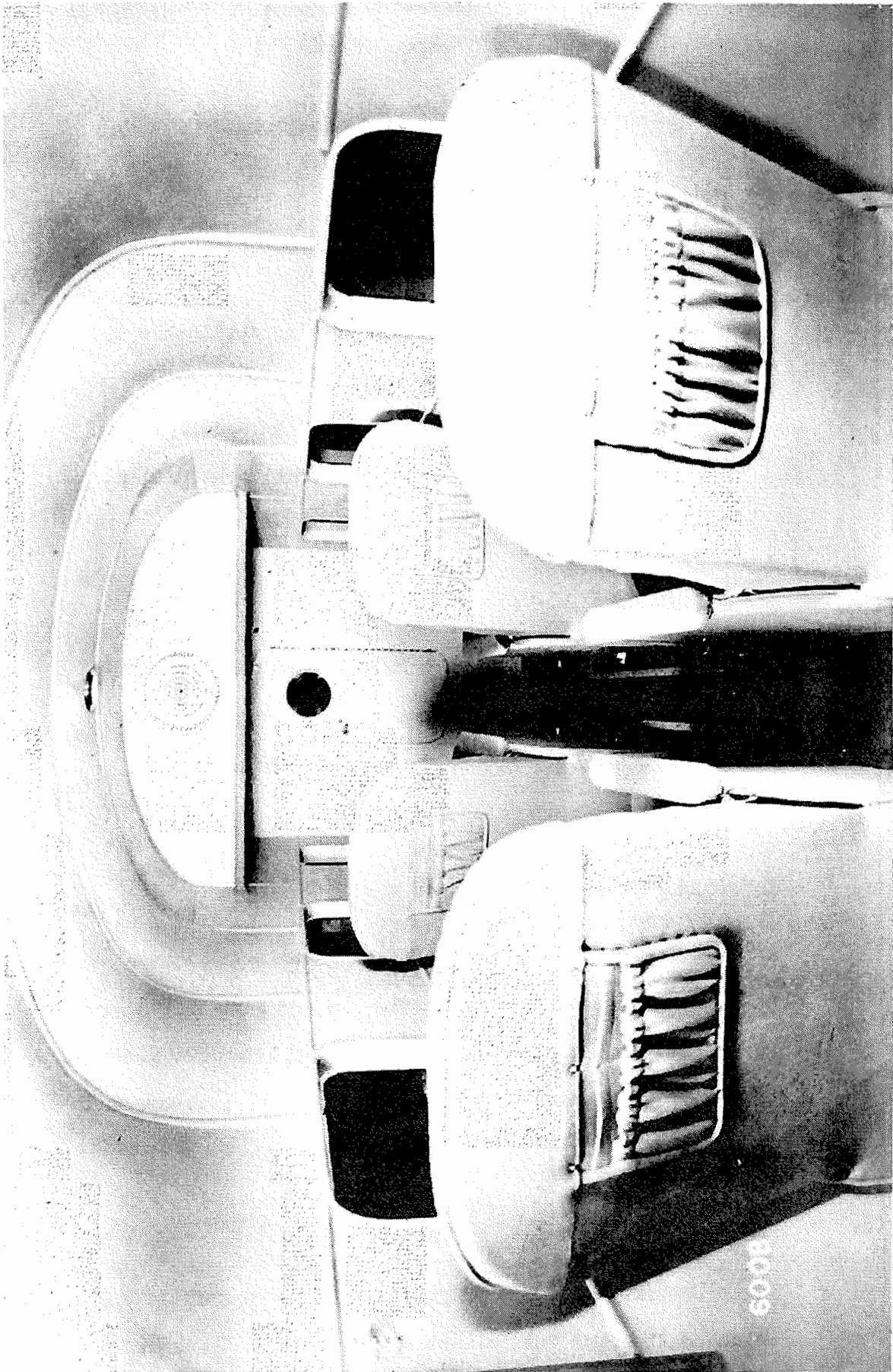

G21A-CABIN INTERIOR - LOOKING FORWARD. FIG. 26

SECTION III
INSPECTION AND LUBRICATION

Inspection

The standard inspection routine applicable to commercial airplanes applies to this airplane.

It is suggested however, that in addition to the routine inspection, special attention be paid to the following items.

Landing Gear

It is recommended that at least once a month, the airplane be hoisted clear of the ground and a thorough check of the retracting mechanism be made. See page 19.

Shock Absorbers

The landing gear and tail wheel shock strut air pressures should be checked before each flight and in addition, the struts should be inspected for possible corrosion pitting of pistons, loss of air pressure and leaks.

Tires

Proper inflation pressure for main wheel tires is 45 lbs. and for tail tire is 50 lbs. Check at regular intervals.

Brakes

Check the oil reservoir every twenty (20) hours (keep 2/3 full) and inspect for possible leaks and abrasion of hydraulic lines.

Maintain proper brake shoe clearance on drums as per instructions contained herein. See pages 39, 40, 41.

Ring Cowl

The ring cowl and attachments should be checked periodically to insure proper fitting on the engine.

Allow for expansion of the engine when clamping the cowl in place.

Lubrication

The lubrication chart contained herein shall be followed when lubricating the airplane.

The chart plainly shows as to unit, points of lubrication, lubricant to be used and time interval between lubrication periods.

All gun type lubricators are marked in yellow paint.

Corrosion Prevention

When operating in salt water, all lubricators exposed to water should be lubricated immediately after every exposure in order to force out water from the joints, thus preventing corrosion and consequent jamming.

Also after each exposure to salt water the entire ship should be washed off thoroughly with fresh water using a hose. Drain plugs should be removed and if any water is inside, that compartment should be thoroughly flushed with fresh water.

All exposed steel bolts and fittings may be effectively protected from corrosion by coating with No-Ox-Id "G-Special" rustproofing compound. This material may be obtained from the Grumman factory or from any branch of Air Associates.

REPORT NO. 1221 A

GEAR	COMPONENT	QUANTITY	LUBRICANT	INTERVAL	REMARKS
2	COMPR STRUT	6	"	20	*
	WHEEL BEARING	4	TEXACO MARFAK ² GREASE	50	"
	GEAR BOX	2	FILL, TEXACO ² GREASE	80	"
	HANDCRANK G UNIT	1	FILL, TEXACO ² GREASE	80	"
	FUS. HINGE POINTS	5	TEXACO MARFAK ² GREASE	20	*
3	COMPR STRUT	1	"	"	*
	CASTER & WHEEL	4	"	"	*
	LOCKING PIN	1	"	"	*
	ROCKER ARM BOX W/IN. BALL BEARING	1	"	"	*
	CABLE BELLCRANK CHAIN	1	TEXACO MARFAK ² GREASE	20	*
4	PUSHROD	1	BRUSH, TEXACO ² GREASE	80	"
	HANDLE	2	LIGHT OIL	50	"
	T.W. LOCK	1	"	50	"
	ELEV. CONTROLS	4	"	20	"
	RUDDER CONTROLS	4	"	20	"
6	FELT SEALS AT FIN POST	1	LIGHT OIL	20	"
	PEDALS	2	RUSTVETO	50	*
	MASTER CYL. ROD ENDS	4	TEXACO MARFAK ² GREASE	50	"
	ROD ENDS	16	LIGHT OIL	"	"
	CARB. HEAT CONTROL ROD ENDS	4	"	"	"
9	PROP. CONTROL ROD ENDS	1	LIGHT OIL	"	"
	TAB HINGE SHAFTS	3	RUSTVETO & PAR-AL-KETONE	"	"
	TAB HINGE	1	"	"	"
	TAB HINGE	1	"	"	"
	SHAF TS	3	"	"	"
10	RUDDER TAB CONTROL	1	"	"	"
	ELEV. TAB CONTROL	1	"	"	"
	SHAF TS	3	RUSTVETO & PAR-AL-KETONE	50	"
	CHAIN	2	BRUSH, TEXACO ² GREASE	80	"
	CABLE ENDS	4	LIGHT OIL	50	"
12	CYLINDER SHAFTS	4	RUSTVETO & PAR-AL-KETONE	70	*
	CYLINDERS	4	"	"	"
	FLAP CONTROL	1	"	"	"
	PILOTS WINDOWS SLIDES	2	NEATSFOOT OIL 4 oz.	200	"
	CONTROL CABLES	2	LIGHT GREASE	50	"
14	WATER TITE FAIRLEADS	2	TEXACO MARFAK ² GREASE	50	HOURS *

* DENOTES PRESSURE LUBRICATOR.
FOR ENGINE LUBRICATION INFORMATION REFER TO ENGINE MANUFACTURERS MANUAL.

LUBRICATION CHART MODEL G-21A

- 14 BALL BEARINGS IN STICK CONTROL UNIT
- 6 " " AILERON HINGES
- 14 " " AILERON BELLCRANKS
- 16 " " AILERON ROCKER ARMS
- 3 " " RUDDER HINGES
- 5 " " ELEVATOR HINGES
- 4 " " ELEVATOR BELLCRANKS
- 4 " " ELEVATOR PUSHRODS
- 8 " " RUDDER CONTROL PEDALS
- 4 " " RUDDER CONTROL PUSHRODS
- 2 " " RUDDER CONTROL BELLCRANKS
- 12 " " WING FLAPS
- 8 " " ENGINE CONTROLS
- 4 " " RUDD. TAB CABLE DRUMS
- 4 " " ELEV. TAB CABLE DRUMS
- 4 " " COCKPIT UNIT-RUDD. TAB CONTROL
- 4 BALL BEARINGS IN COCKPIT UNIT-ELEV. TAB CONTROL
- 7 BALL BRG. PULLEYS IN ELEV. CONTROLS
- 14 " " ELEV. & RUDD. TAB CONTROLS
- 7 " " RUDDER CONTROLS
- 8 BALL BRG. PULLEYS IN AILERON CONTROLS

IMPORTANT:
FOR CARE OF ALL CONTROL SURFACE HINGES SEE SERVICE BULLETIN N° 1.

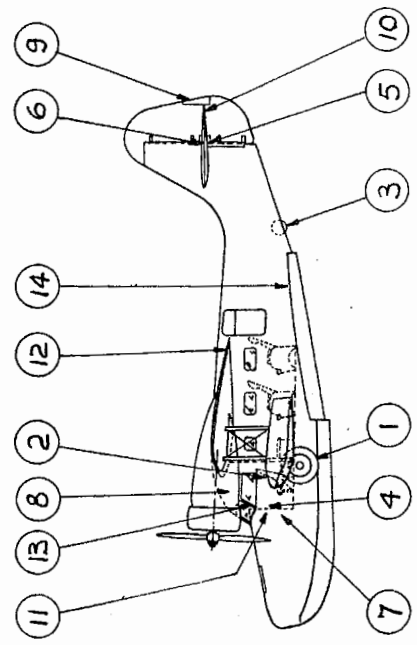

27

Windows

All windows including windshield are of various thicknesses of Plexiglass, a superior plastic material of exceptional clearness. This material is not affected by sunlight, salt water, gasoline or oil and will not crack or discolor with age.

While it is considerably harder than ordinary pyralin, it will scratch if cleaned with gritty rags. Always be careful to wipe off with clean soft rags, thoroughly loosening dirt or grease with water or gasoline before rubbing hard. Scratches, even deep ones, may be removed as follows:-

Small scratches: Work out with a turpentine and chalk mixture and polish with Berryloid Lacquer Polish using clean flannel rag. As the polishing material in this product is extremely fine, considerable patience is required for a fine job.

Deep scratches: Wet sand with #420 Wet-or-Dry paper until scratches disappear. Remove sandpaper frosting with "Kenite" rubbing compound, finally finishing off with chalk and Berryloid polish as above. A soft buffing wheel mounted in an electric drill will reduce labor involved in the final polishing operation.

Engine and Accessories

The following standard items of equipment used on this airplane are listed below, together with name and address of the respective manufacturer.

Questions arising relative to care, maintenance or repair of these parts may be referred directly to the respective manufacturer's instruction manual.

Engines

Pratt & Whitney Wasp Junior S-B
Pratt & Whitney Aircraft Co.
Hartford, Connecticut

Starters

Eclipse E-160
Eclipse Aviation Corp.,
East Orange, New Jersey

Master Brake Cylinders & Shock Struts

Bendix Brake Co.,
South Bend, Indiana

Wheel & Brakes

30 x 7 Wheels & Hydraulic Brakes
Hayes Industries, Inc.,
Jackson, Michigan

Tail Wheel

Fork Mounting type Hayes #D3-57-A
Hayes Industries, Inc.
Jackson, Michigan

Propellers

Controllable Pitch 8'-6" dia.

Hamilton Standard Propeller Co.,

Hartford, Connecticut

Pressure Fire Extinguisher

"Lux" Type A-1

Walter Kidde & Co., Inc.

140 Cedar Street

New York City, New York

Tires & Tubes

32 x 8 - 6 ply on main wheels

13-1/4 dia. Streamline, 6 ply heavy duty, on tail wheel.

B. F. Goodrich Company

Akron, Ohio

EQUIPMENT RECORD

SERIAL NO. MODEL DATE MFG. D.C. LICENSE NO.

OWNER (1) _____ ADDRESS _____
(2) _____
(3) _____

SERVICE BULLETINS TO (1) _____
(2) _____
(3) _____

WEIGHT EMPTY AS EQUIPPED _____ FUEL CAP. _____ OIL CAP. _____

PAINT

WINGS - Metal Parts _____
Fabric _____

HULL _____

CABIN _____

COCKPIT _____
REMARKS _____

UPHOLSTERY

ATTACH CABIN CHAIRS Make _____ Style No. _____
 COCKPIT CHAIRS Make _____ Style No. _____
SAMPLES FLOORS _____
 SAFETY BELTS _____
HERE REMARKS _____

POWER PLANT

ENGINES _____ Serial Nos. L. _____ R. _____
Gen. drive _____ Vac. Pump drive _____ Auto Lub. _____ Gov. Drive _____
Remarks _____

PROPELLERS Hub Design No. _____ Serial Nos. L. _____ R. _____
 Blade Design No. _____ Serial Nos. L. _____ R. _____

CARBURETORS Make _____ Model _____ Serial Nos. L. _____ R. _____

STARTERS Make _____ Model _____ Serial Nos. L. _____ R. _____

FUEL PUMPS Make _____ Model _____

VACUUM PUMPS Make _____ Model _____

REMARKS _____

EQUIPMENT RECORD

ELECTRICAL

GENERATOR(S) Make _____ Model _____ Size _____
 BATTERY Make _____ Model _____ Amp. Hrs. _____ Wt. _____
 LANDING LIGHT(S) Make _____ Model _____
 FOG LIGHT Make _____ Model _____
 NAV. LIGHTS Make _____ Model _____
 FUSES (List all sizes, makes, styles) _____

RADIO

LANDING GEAR

WHEELS - FRONT Make _____ Model _____ TAIL Make _____ Model _____
 TIRES - FRONT Make _____ Size _____ Tread _____ Tubes _____
 REAR Make _____ Size _____ Tread _____ Tube _____

INSTRUMENTS (List make and model)

TACHOMETERS _____ MAN. PRES. _____
 ENGINE GAGE UNITS _____ CARB. AIR _____
 ALTIMETER _____ CLIMB _____
 AIRSPEED _____ TURN & BANK _____
 COMPASS _____ HORIZON _____
 GYRO _____ CLOCK _____
 ICE WARNING _____ THERMOCOUPLE _____
 OTHERS _____

KEY NOS. _____

ADDITIONAL INFORMATION (Use separate sheets if necessary)

Supplementary Instruction Manuals

The following instruction manuals, compiled by the various manufacturers are furnished with each airplane and considered a part of this manual.

Engine Instruction Manual	- Pratt & Whitney	
Propeller Instruction Manual	- Hamilton Standard	
Starter Instruction Manual	- Eclipse	
Fire Extinguisher Instruction Manual	- Lux - Walter Kidde	
Generator Instruction Manual	- Eclipse	
Battery Instruction Manual	- Exide	
Directional Gyro Instruction Manual	- Sperry	} If installed
Artificial Horizon Instruction Manual	- Sperry	
Fuel Analyzer Instruction Manual	- Cambridge	

Grumman Model G-21A Airplane

Subject: Ball Bearings used in Control Surface Hinges.

The bearings that were installed in G-21A amphibians serial Numbers 1001 to 1022 inclusive and 1048 and 1049 were the standard Fafnir SLK-5 sealed type ball bearing. On several ships that have had a lot of salt water operation, we have found these bearings rusted and in one extreme case, the balls were completely gone from two bearings. As a result, we have now procured from Fafnir a new lot of these bearings which have an improved grease seal and which are packed with a mixture of grease and #350 Alox compound. This latter material inhibits corrosion and does not affect the lubricating qualities of the grease. These new bearings are designated as type SLK-5N.

If these bearings are allowed to become so rusted that they develop play, it is possible for vibrations to occur and possibly even flutters. On one ship we found several of the flap hinge brackets on the wings with cracks started in them which are undoubtedly the result of vibration of this flap, due to the play in the hinges from the rusted out bearings.

It is therefore recommended that all owners have the aileron, flap, elevator and rudder hinges checked to see if the bearings have started to rust, and also it is advisable to check the flap hinge brackets on the wings even though we have checked several other ships and found no other cracks. The cracks developed in the lower end of the bend line between the leg of the bracket and the flange that is bolted onto the wing. At the outboard fittings it will be necessary to cut the fabric to inspect them.

It is also recommended that the hinge bolts be checked wherever any bearings with play in them have been found as they will probably show signs of wear and need replacing in order to prevent any play being left in the hinge.

All rusted bearings should be replaced with the new type bearings of which we now have an ample supply and they should be protected after installation with Par-Alkstone and then covered with No-Ox-Id or a mixture of beeswax and grease.

Until operating experience indicates that it is no longer necessary, it is recommended that the hinge bearings be checked every 50 hours for those ships operating steadily from salt water and every 100 hours for the other ships.

REPORT NO.

April 13, 1939

SERVICE BULLETIN NO. 4

Grumman Model G-21A Amphibian

Subject: Directions for easily replacing the airplane on its wheels, if resting on its keel.

If for any reason this airplane is resting on its keel, because of being grounded on a beach by a falling tide or landed on land with the wheels retracted, the quickest and easiest way to put it back on its wheels is as follows:

1. Remove both wheels.
2. Crank the gear all the way out.
To do this it will be necessary to let the air out of the shock struts. Do this slowly by cracking the valve only a little first. If it is done slowly only a very small amount of oil will be lost and it will not squirt out.
3. Jack up each side of the airplane under the axles.
4. When just high enough, put the wheels back on.
5. Jack the airplane down and remove the jacks.
6. Re-establish the correct air pressure in the shock struts.

April 12, 1939

SERVICE BULLETIN NO. 5

Grumman Model G-21A Airplane

(Supplement to Service Bulletin No. 1)

Subject: Ball Bearings used in Control Surface Hinges.

In Bulletin No. 1 it was advised that the special ball bearings Grumman had Fafnir develop for use in the control surface hinges on the model G-21A amphibian, were to be designated as SlK-5N. It is now found that this designation has been applied by Fafnir to this type of bearing whether they are packed with the special Alox grease compound or with the standard grease.

If these bearings are ordered direct from Fafnir or from some other source, it is suggested that it be definitely specified on the order that these bearings be packed with Alox grease compound, as furnished to Grumman. All SlK-5N Bearings supplied by Grumman have been so packed.

July 18, 1946

MODEL G21/1R AIRCRAFT
SERVICE BULLETIN
NO. 19

Subject: INSPECTION OF FLAP VACUUM SYSTEM STORAGE TANK AND CHECK VALVES AND RELOCATION OF SYSTEM TUBING IN ENGINE COMPARTMENT

Reference: Wing Flap System Installation in Erection Manual

History: It has been brought to the attention of the factory that in some instances small quantities of fuel have been found in the flap system storage tank located in the bow of the aircraft. It accumulated there by leakage from the carburetor adapters SP-36 through the check valves 6HBB-D (Parker No. 12-2236-5B). The presence of this fuel creates a definite hazard in that backfire from an engine might pass a badly worn or deteriorated check valve and reach the tank. In one instance when the check valves were inadvertently omitted during an overhaul a backfire caused a serious explosion.

Action: It is recommended that the following action be taken immediately on all aircraft:

1. The flap system storage tank be inspected and, if fuel is found, that it be thoroughly flushed, preferably with carbon tetrachloride. There is a drain plug in the bottom of the tank.
2. The check valves be removed and inspected for wear or deterioration. Presence of fuel in the storage tank is sufficient cause for replacement of the valves. It is recommended that the existing type valves, Parker No. 12-2236-5B, be used for replacement. They incorporate a metal to metal seat slide valve plus a rubber disc check to insure air tightness. If these are not available, Parker valve No. 525-GG-1/4D with 2 pieces No. 6FB inserted, may be substituted.
3. Reroute the vacuum system tubing in the engine compartments in accordance with enclosed Sketch #1. THIS SHOULD BE DONE IN ALL CASES IRRESPECTIVE OF THE ACTION TAKEN IN ITEMS 1 AND 2 ABOVE. The loop in the tubing will prevent raw fuel from trickling down and lodging in the check valve thus deteriorating it and possibly seeping through.

Inspection: A periodic check for fuel in the vacuum tank should be made at 20 hour intervals.

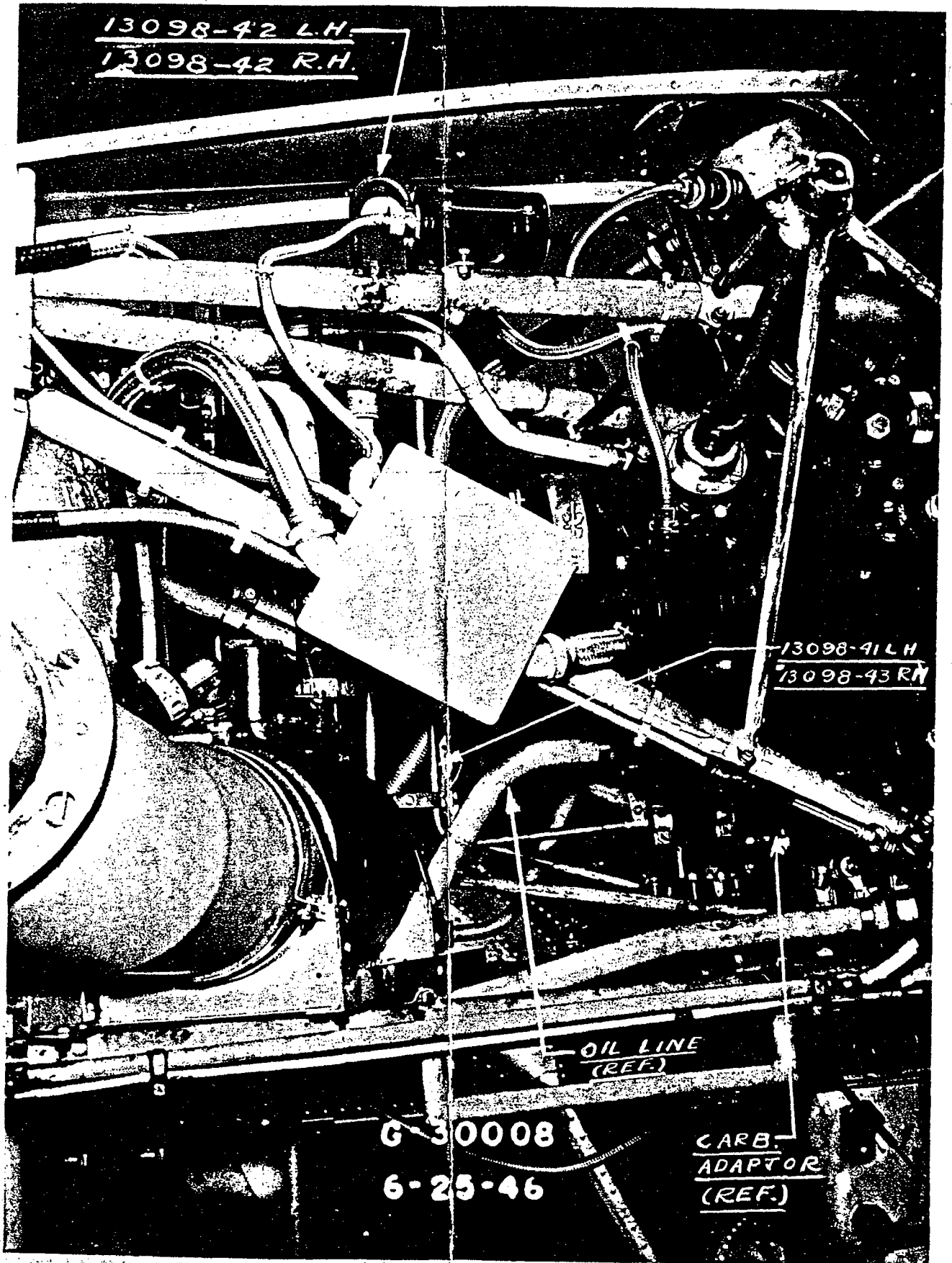

13098-42 L.H.
13098-42 R.H.

13098-41 L.H.
13098-43 R.H.

OIL LINE
(REF.)

G-30008
6-25-46

CARB
ADAPTOR
(REF.)

FIGURE 2

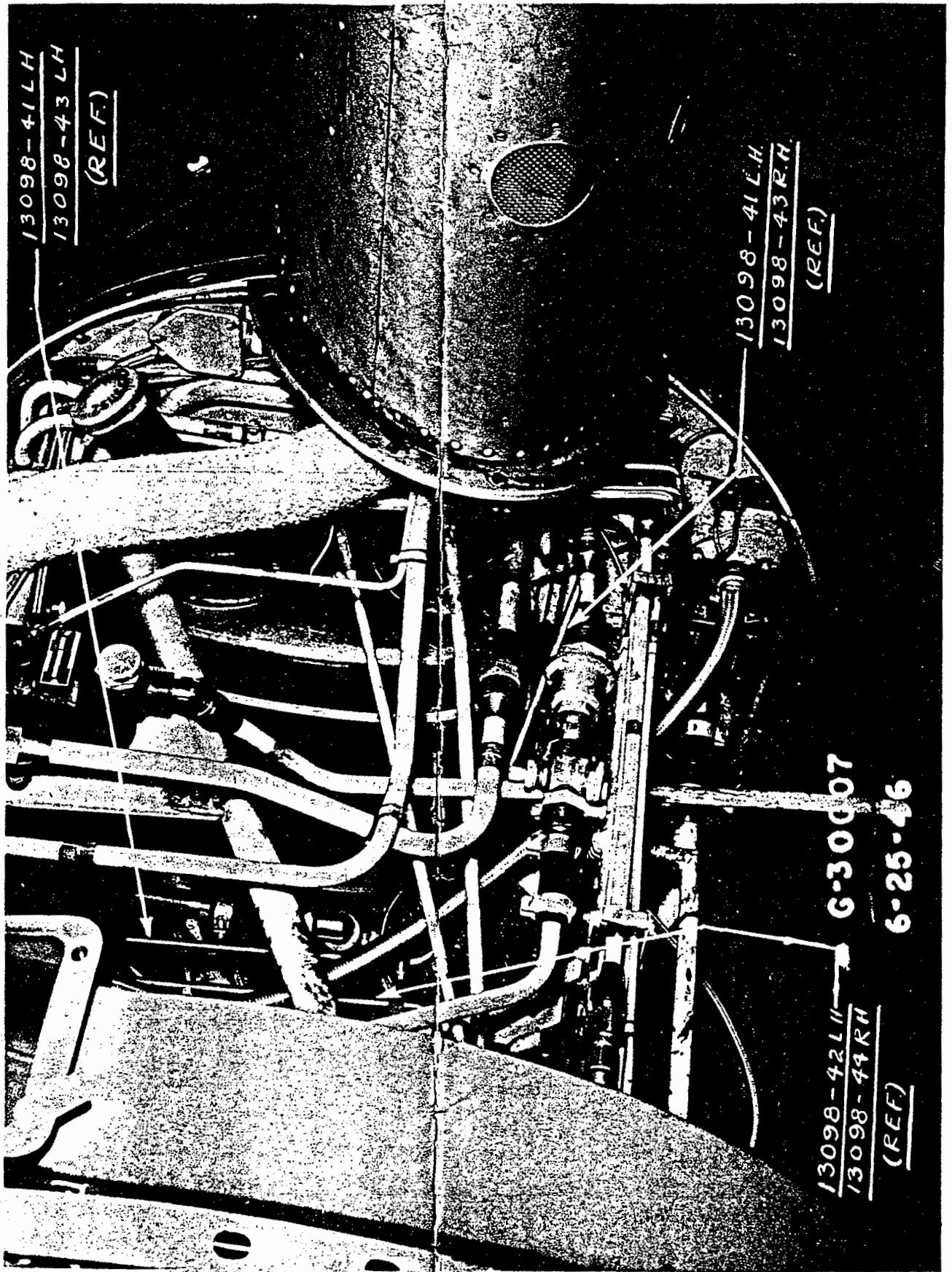

13098-41LH
13098-43LH
(REF)

13098-41LH
13098-43RH
(REF)

13098-42LH
13098-44RH
(REF)

G-30007
6-25-46

FIGURE 3

PLACE FABRIC IMPREGNATED WITH PRIMER BETWEEN COUPLINGS.

- 12630-L WORM GEAR BOX ASSEM.
- 12631 (4) SPACER
- AN5-33 (4)
- AN310-5 (4)
- AN380-2-3 (4)

- 12052 (REF) BULKHEAD
- AN5-20
- AN310-5
- AN380-2-3
- 12079 (REF) COMP. LINK FITTINGS

REFERENCE LINE

- 12604-L L.G. COMP. LINK
- 9606-3 BUSHING
- AN6-27
- AN310-6
- AN380-3-3

- G2-4 LUBRICATOR
- SHOCK STRUT (BENDIX #53590)

- 9606-2 BUSHING
- AN10-37
- AN310-10
- AN380-4-4

- 12080 (REF) DRAG LINK FITTINGS
- 12051 (REF) BULKHEAD
- 9603-L UPPER DRAG LINK

- G2-14 LUBRICATOR
- 9606-4 (2) BUSHING
- AN10-27 (2)
- AN310-10 (2)
- AN380-4-4 (2)

9602-L LOWER DRAG LINK

- 12628-L ASSEM. FAIRING
- AN345-10 (1)
- AN520-10-8 (1)

POSITION OF WHEEL WITH OILFO FULLY COMPRESSED

- 3 13/16 (REF)
- 3 15/16 (REF)

POSITION OF WHEEL UNDER STATIC LOAD

ASSEM. AN502-10-8(G) LOCK WIRE HEADS IN PAIRS.

- 12625-2 MAINTAINED BY 12052

TO LOWER TO RAISE
ED FOR CRANK TIGHTEN (PIVOT) TO IN BOTH DIRECTIONS

WHEEL

AXLE

AIRPLANE

- 9606-7 BUSHING
- 9609 SPECIAL BOLT
- AN310-10
- AN380-4-4

- 9606-1 BUSHING
- 9676 SPECIAL BOLT
- AN310-12
- AN380-4-5

12601 AXLE MEMBER

STA #13

STA #11

LANDING GEAR STRUCTURE IS SYMMETRICAL ABOUT E OF AIRPLANE.

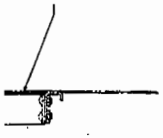

-GM-3 CLIP
AM350-10-6 (A)
AM345-70 (B)

-INSTRUMENT PAVEL:
1E025 (REC)

-LOCKED POSITION

-TUM WHEEL CASTOR
LOCK OPERATING
HANDLE

-1E662 HANDLE PLATE
AM350-10-6 (A)
AM345-70 (B)

-UNLOCKED POSITION

-SM-2
AM350-10-6 (A)
AM345-70 (B)

REF. LINE 7

-ADJUSTABLE CORNER PULLEY
(WALTER KIDDE & CO.) (C)

AM370-70-8 (A)
AM345-70 (B)

FLOOR LINE

9

1E660 (REF)
HAND CRANK GEAR BOX

TUM WHEEL MESH LINK
AM345-70 (B)
AM310-10 (C)
AM310-10 (C)
AM300-2-E (D)

1E637-1
AM345-70 (B)
AM310-10 (C)
AM300-2-E (D)

1E635 BELL CRANK ASSEM

1E637 PUSH ROD
AM345-70 (B)
AM310-10 (C)
AM300-2-E (D)

1E636
BELL CRANK ASSEM

9763-J GUIDE
AM350-10-10 (B)
AM335-70 (C)

FLOOR LINE

1E745 (REF)
PULLEY INSTALL

1E749 (REC)
FAIRLEAD

1E742 (REF)
PULLEY INSTALL

1E748 (REC)
FAIRLEAD

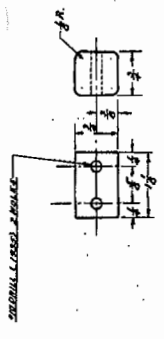

1E630-3

NOTES

- 1-BEFORE MOUNTING THE WHEEL AT WORK MANU LOADING GEAR. WHEELS ARE PROPERLY ANCHORED.
- 2-ADJUST TUM WHEEL OPERATING HANDLE THROUGH WHEEL TO THAT AS THE HANDLE OPERATING HANDLE IS FULLY DOWN AND WHEEL LAUNCH IS COMPLETELY DOWN 1 TURN OF THE HANDLE CRANK BEFORE THE HANDLE CRANK REVEALS ITS FULL DOWN POSITION.
- 3-LUBRICATE WITH MARCAR-2 GREASE.
- 4-SATURATE TUM WHEEL FEET WASHERS WITH LINDSAY OIL.

ALL G.L. FIN TO FIN ASSEM.
 AT A19 1200-4 WITH 1/8" D.
 BR HD RIVETS AN455-D4-5
 SPACE 1" APART

15533-FIN ASSEM.
 FIN
 L.H. STABILIZER

GA-9-8 (FORM)
 AN3-6 DRILL HOLES
 AN380-3
 AN380-2-2
 SAFETY WIRE HEADS

AN5-14
 AN310-5
 AN380-2-2

VIEW
 SHOWING
 & FIN AT

ATTACH ELEVATORS TO
 ELEVATOR HOORN WITH
 C-34-4-7 (A)
 AN4-34 (A)
 AN310-4 (A)
 AN380-2-2 (A)

GA-9-20
 AN4-34 (A)
 SAFETY WIRE HEADS

STABILIZER

RIVET FIN TO FINPOST 180°
 WITH AN455-D4-5 SPACE 1" APART
 DRILL & TAP #8-32 AT EACH
 FIN END FOR ATTACH TO FIN
 POST WITH BLAD # 8-32
 TAP SCREWS AN550-8-5
 SPACE 1" APART

GA-9-20
 DRILL HOLES
 SAFETY WIRE HEADS

15539-RIVET WITH
 AN430-26-7
 FRONT FACE STAB BEAM

15531-ROCKER ASSEM

VIEW
 SHOWING
 TO FIN AT
 SHOWING
 ELEV TO
 & ELEV

1-1
 BLADE-RIPPER TAB CONTROL
 ACCESS #0-32 C-SUNK JOB
 SCREWS AN50-10-6
 WITH C-SUNK PLATE

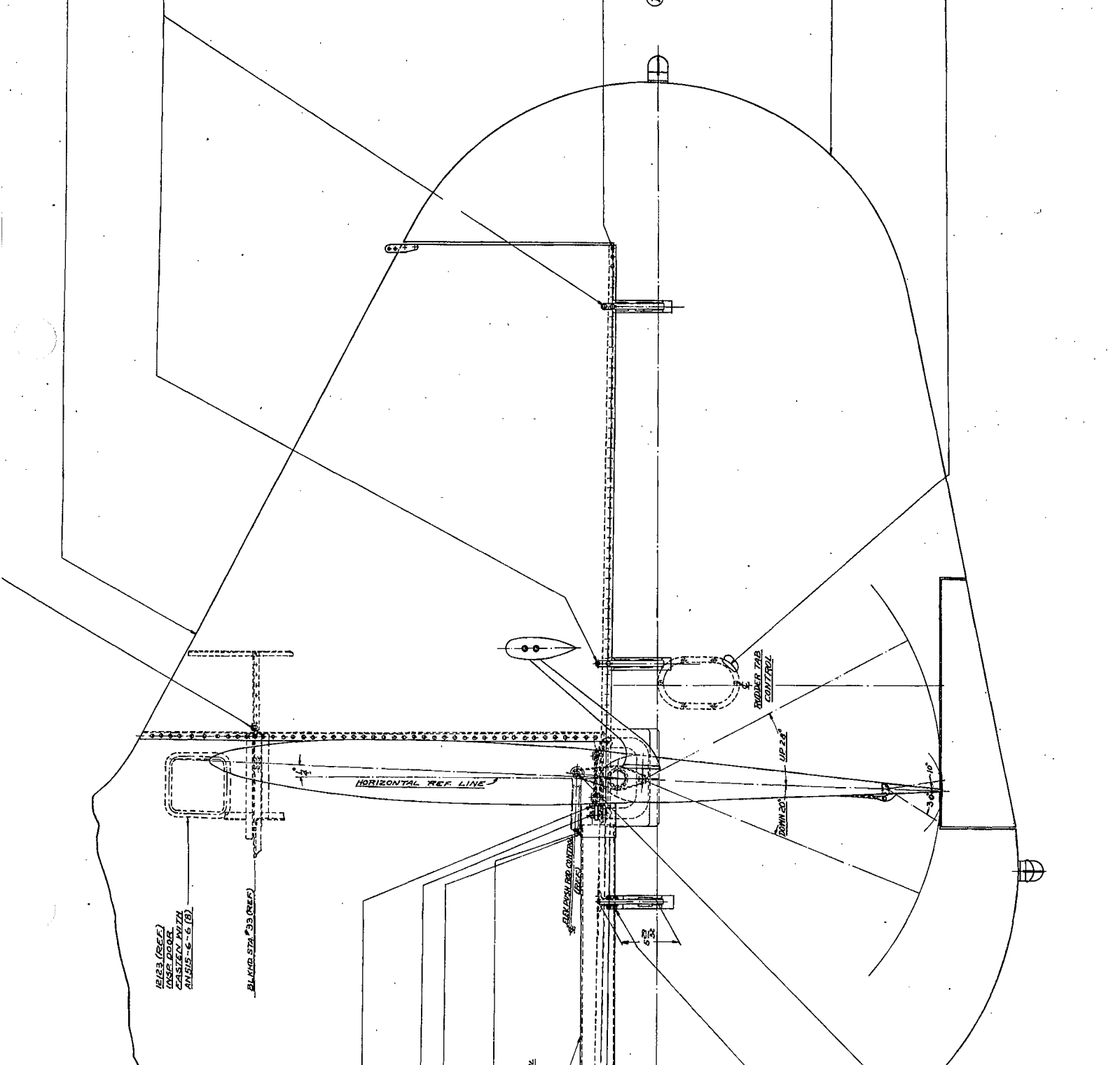

1523 (REF)
 AN380-2-2
 AN310-4
 AN310-5

BLAD #8-32 (REF)

BLAD #8-32 (REF)

ROCKER TAB CONTROL

UP 2.5°
 DOWN 20°

HORIZONTAL REF LINE

3.0 ± .10

VIEW

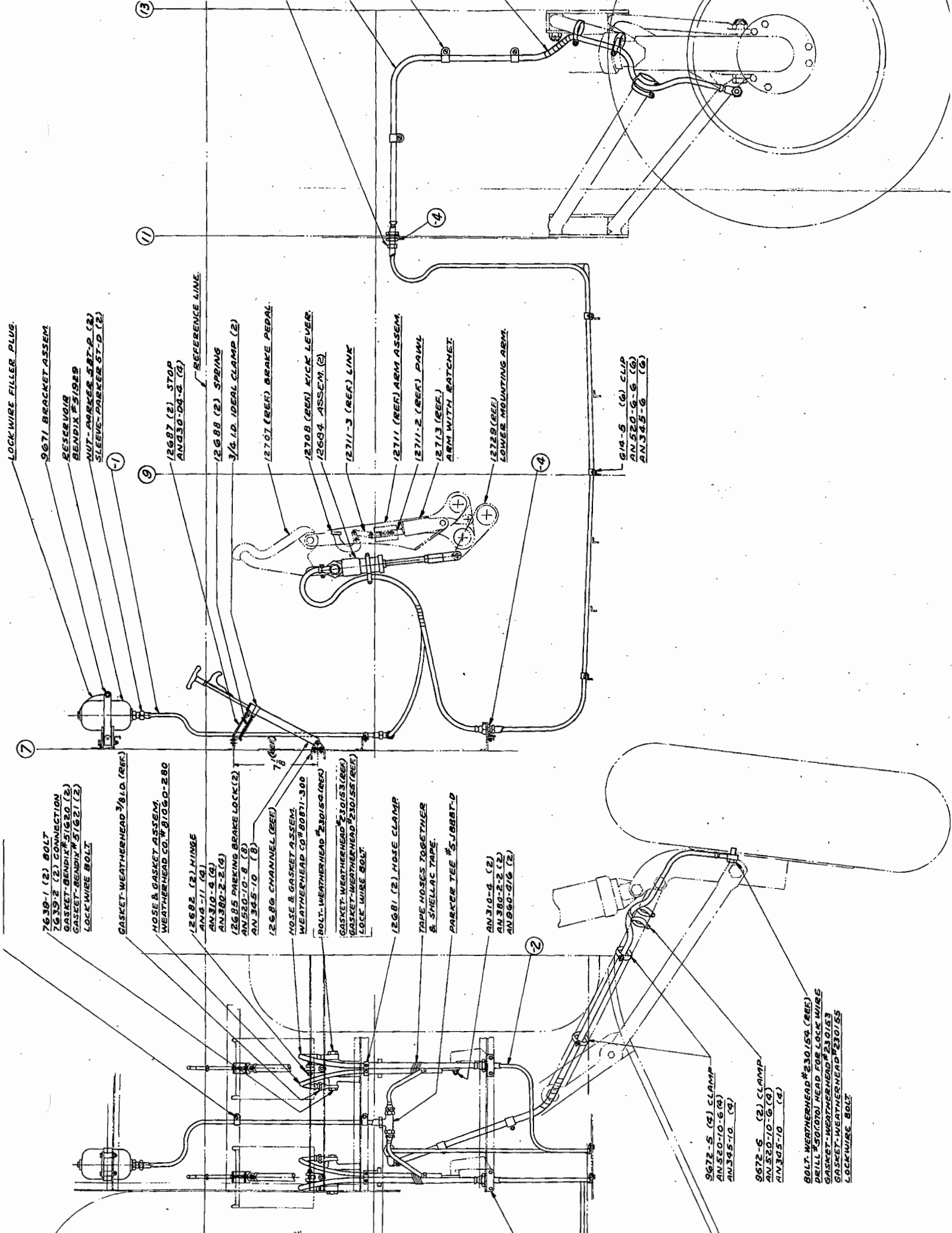

LOCKWIRE FILLER PLUG
 9071 BRACKET ASSEM
 RESERVUOIR
 BENDIX #51929
 NUT-PARKER 5BT-P (2)
 SLEEVE-PARKER 5T-D (2)

7639-1 (2) BOLT
 7639-2 (2) CONNECTION
 GASKET-BENDIX #21013 (2)
 GASKET-BENDIX #51621 (2)
 LOCKWIRE BOLT
 GASKET-WEATHERHEAD #810 (REF)
 HOSE & GASKET ASSEM.
 WEATHERHEAD CO #91060-280

12687 (2) STOP
 AN330-04-2 (4)
 REFERENCE LINE
 12688 (2) SPRING
 3/4 I.D. IDEAL CLAMP (2)

12682 (2) HINGE
 AN310-4 (4)
 AN380-2-2 (4)
 12685 PARKING BRAKE LOCK (2)
 AN520-10-8 (8)
 AN345-10 (8)
 12686 CHANNEL (REF)
 HOSE & GASKET ASSEM.
 WEATHERHEAD CO #80811-300
 BOLT-WEATHERHEAD #230159 (REF)
 GASKET-WEATHERHEAD #230153 (REF)
 GASKET-WEATHERHEAD #230155 (REF)
 LOCKWIRE BOLT

12707 (REF) BRAKE PEDAL
 12708 (REF) KICK LEVER
 12694 ASSEM. (2)
 12711-3 (REF) LINK
 12711 (REF) ARM ASSEM
 12711-2 (REF) PAWL
 12713 (REF) ARM WITH RATCHET
 12729 (REF) LOWER MOUNTING ARM

12681 (2) HOSE CLAMP
 TAPE HOSES TOGETHER & SHELLAC TAPE
 PARKER TEE #51088T-D
 AN310-4 (2)
 AN380-2-2 (2)
 AN590-016 (2)

614-5 (6) CLIP
 AN520-6-6 (6)
 AN345-6 (6)

9672-5 (4) CLAMP
 AN520-10-6 (4)
 AN345-10 (4)
 9672-6 (2) CLAMP
 AN520-10-6 (4)
 AN345-10 (4)
 BOLT-WEATHERHEAD #230159 (REF)
 DRILL #30 (070) HEAD FOR LOCKWIRE
 GASKET-WEATHERHEAD #230153
 GASKET-WEATHERHEAD #230155
 LOCKWIRE BOLT

9672-5 (4) CLAMP
 AN520-10-6 (4)
 AN345-10 (4)
 9672-6 (2) CLAMP
 AN520-10-6 (4)
 AN345-10 (4)
 BOLT-WEATHERHEAD #230159 (REF)
 DRILL #30 (070) HEAD FOR LOCKWIRE
 GASKET-WEATHERHEAD #230153
 GASKET-WEATHERHEAD #230155
 LOCKWIRE BOLT

9672-5 (4) CLAMP
 AN520-10-6 (4)
 AN345-10 (4)
 9672-6 (2) CLAMP
 AN520-10-6 (4)
 AN345-10 (4)
 BOLT-WEATHERHEAD #230159 (REF)
 DRILL #30 (070) HEAD FOR LOCKWIRE
 GASKET-WEATHERHEAD #230153
 GASKET-WEATHERHEAD #230155
 LOCKWIRE BOLT

9672-5 (4) CLAMP
 AN520-10-6 (4)
 AN345-10 (4)
 9672-6 (2) CLAMP
 AN520-10-6 (4)
 AN345-10 (4)
 BOLT-WEATHERHEAD #230159 (REF)
 DRILL #30 (070) HEAD FOR LOCKWIRE
 GASKET-WEATHERHEAD #230153
 GASKET-WEATHERHEAD #230155
 LOCKWIRE BOLT

9672-5 (4) CLAMP
 AN520-10-6 (4)
 AN345-10 (4)
 9672-6 (2) CLAMP
 AN520-10-6 (4)
 AN345-10 (4)
 BOLT-WEATHERHEAD #230159 (REF)
 DRILL #30 (070) HEAD FOR LOCKWIRE
 GASKET-WEATHERHEAD #230153
 GASKET-WEATHERHEAD #230155
 LOCKWIRE BOLT

9672-5 (4) CLAMP
 AN520-10-6 (4)
 AN345-10 (4)
 9672-6 (2) CLAMP
 AN520-10-6 (4)
 AN345-10 (4)
 BOLT-WEATHERHEAD #230159 (REF)
 DRILL #30 (070) HEAD FOR LOCKWIRE
 GASKET-WEATHERHEAD #230153
 GASKET-WEATHERHEAD #230155
 LOCKWIRE BOLT

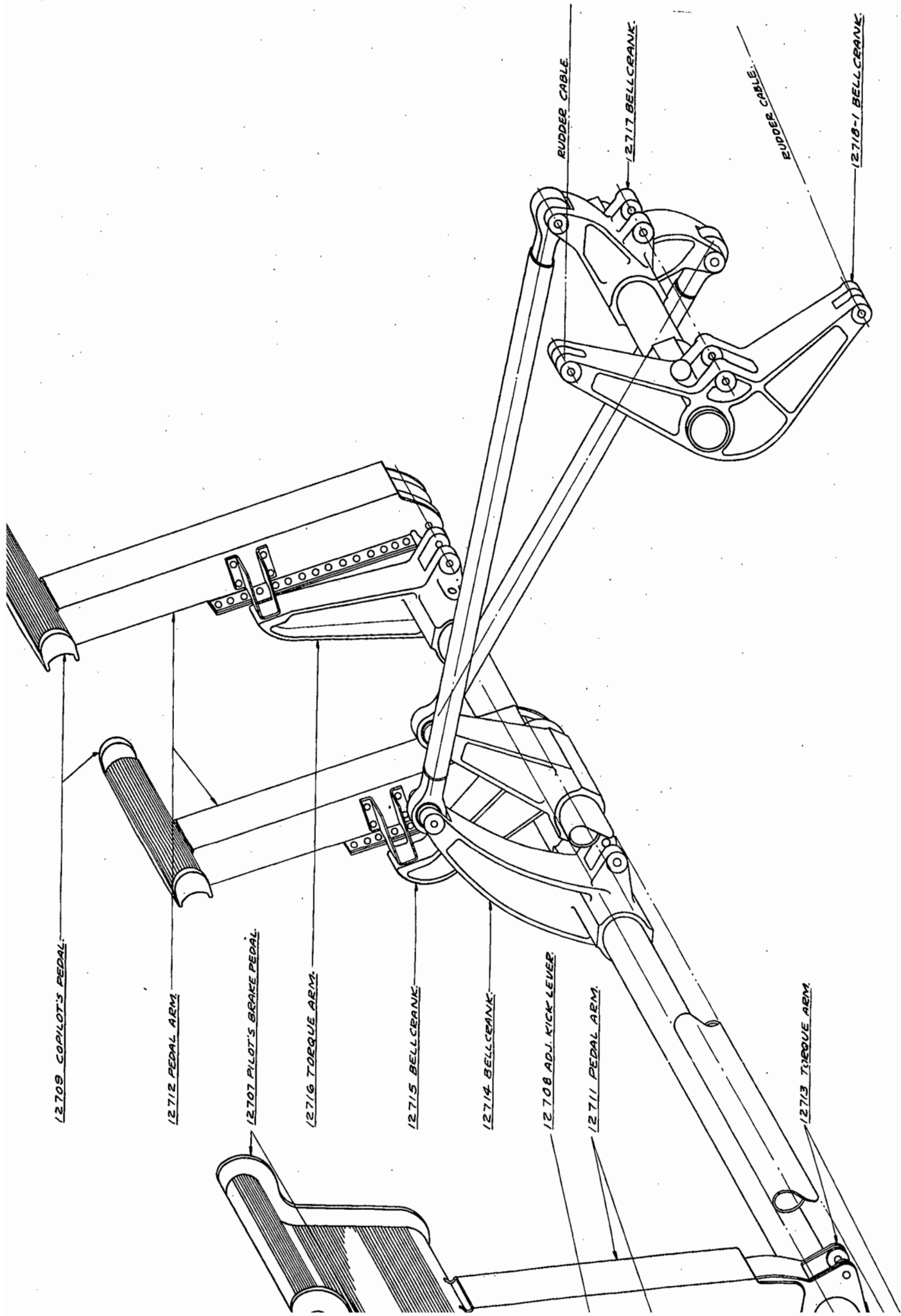

12709 COPLOT'S PEDAL

12712 PEDAL ARM

12707 PILOT'S BRAKE PEDAL

12716 TORQUE ARM

12715 BELLCRANK

12714 BELLCRANK

12708 ADJ. KICK LEVER

12711 PEDAL ARM

12713 TORQUE ARM

RUDDER CABLE

12717 BELLCRANK

RUDDER CABLE

12718-1 BELLCRANK

RUDDER CONTROL PE 1LS

12

12

12

12

12

12

12

12

12

12

12

TAB

7/16

3/16

3/16

NOTES:

1. ALL PULLEYS LOCATED ALONG C OF SW
2. TO CONNECT TAB CONTROL CABLES AN140-165 (4) TURNBUCKLES WITH TURN BUCKLE 4" AFT OF STA #19
3. TO CONNECT ELEVATOR & RUDDER C USE AN140-32L (4) TURNBUCKLES. BE STA #19 & STA #23.
4. PULLEY BRACKET 12742 INSTALLED 1
5. FAIRLEADS 12749 & 12747 INSTALLED

THRUST (REG)

12739 PULLEY BRACKET

CABLE - 5/32 DIA. (7X19)

RUDDER TAB CONTROL
MOUNTED ON L.H. DECKFIT WALL
12777-12 MOUNTING PLATE

ELEVATOR TAB CONTROL
MOUNTED ON AISLE SIDE OF L.H. PILOT'S CHAIR
12777-9 MOUNTING PLATE

BREEZE FLEXIBLE SHAFTING
WS-0250-X-2-1/4 4' LONG

BREEZE FLEXIBLE SHAFTING
WS-0250-X2-45' LONG

7853 TAB CONTROL STOPS (4)

12728 PULLEY BRACKET
12735 FAIRLEAD

12741 PULLEY BRACKET
12778-TAB CONTROL DRUM
12722 SHAFTS SUPPORT ASSEM.
(INCLUDING RUDDER PEDAL STOP)

ON LEFT SIDE-ELEV BELL CRANK
TORQUE TUBE ASSEM. 12755

ON RIGHT SIDE-RUDDER
BELL CRANK TORQUE TUBE
ASSEM. 12756

16

13

11

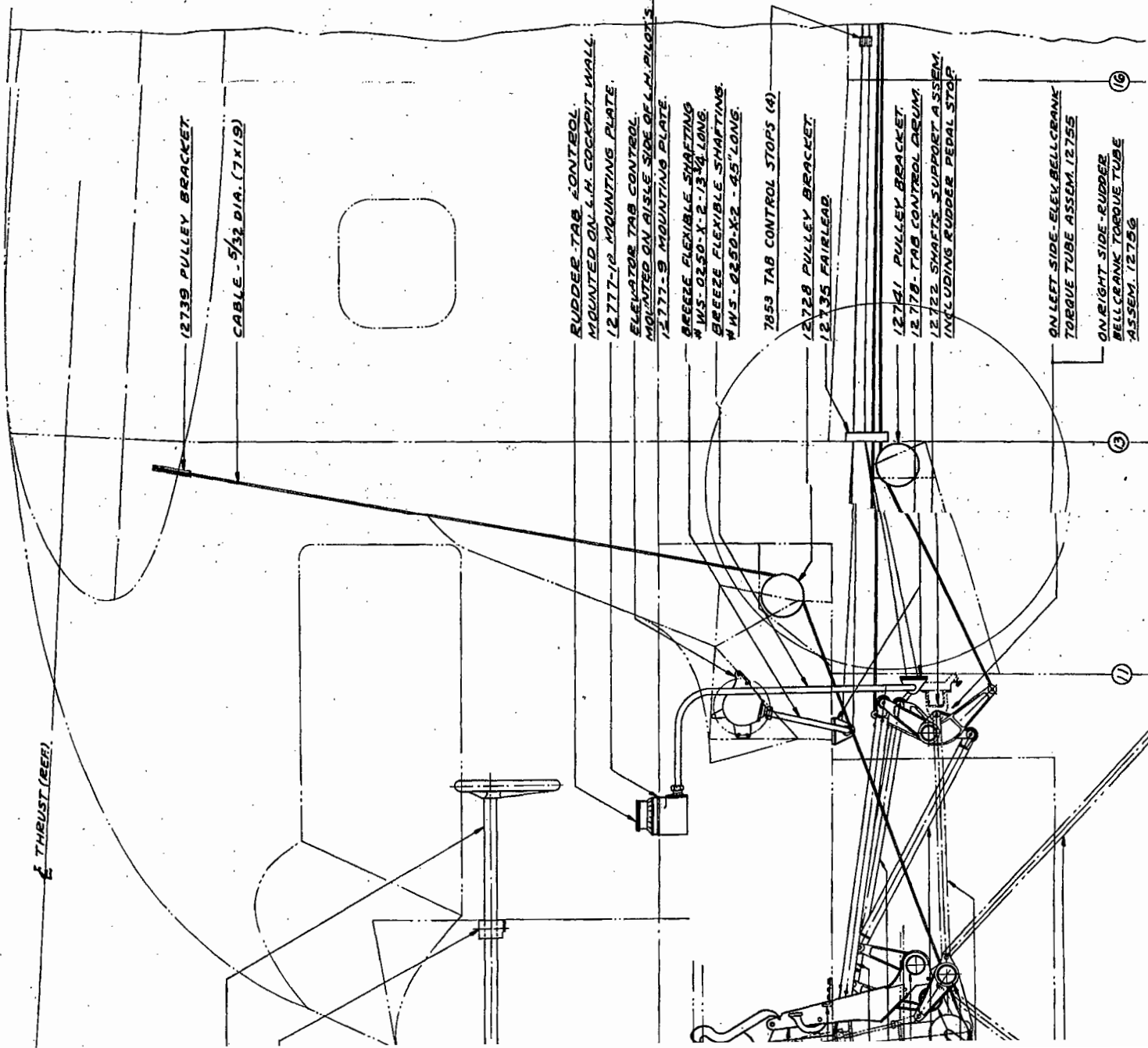

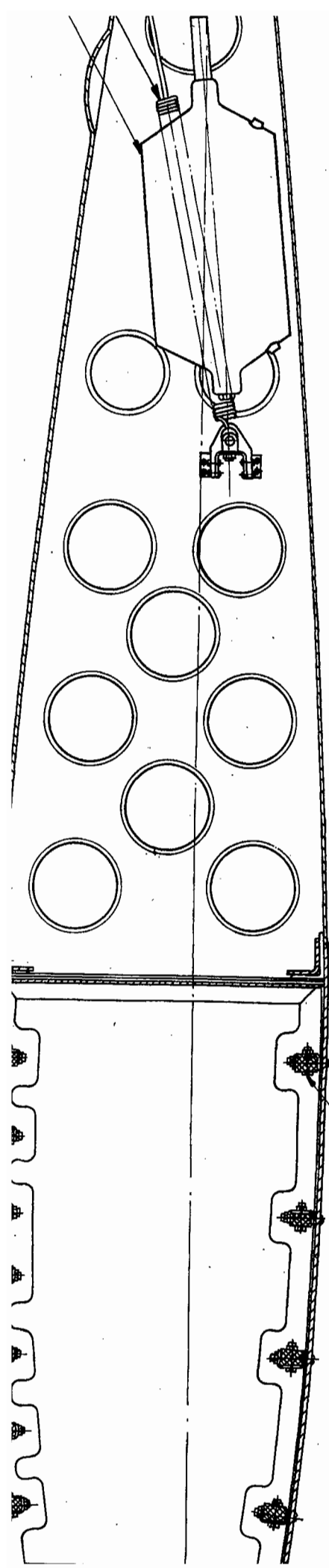

2-10
310-4
380-2-2

44 PER AIRPLANE

SECTION THRU WING AT
CONNECTION OF OUTBOARD PANEL

25-20
320-5
380-2-2

44 PER AIRPLANE

PUSH PULL TUBE

BOLT AN4-11
NUT AN310-4
COTTER AN380-2-2

2 PER AIRPLANE

HORN

HINGE

AILERON

HOOD

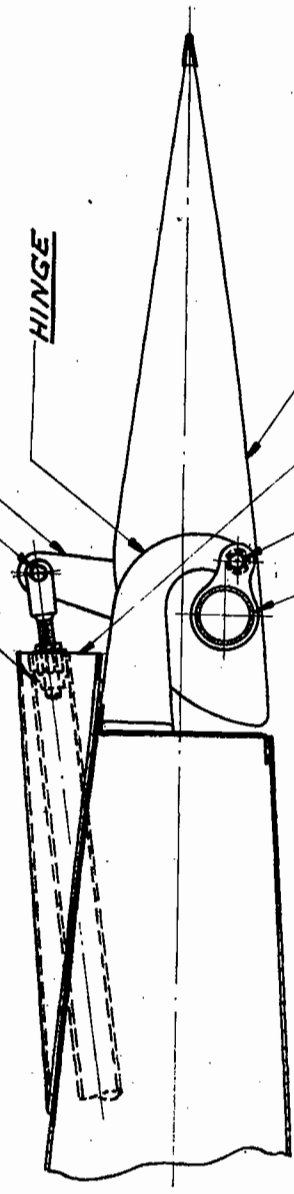

SECTION THRU WING AT AILERON

BOLT AN4-14
NUT AN310-4
COTTER AN380-2-2
BALL BRG. 51K-5

PER AIRPLANE

3/8 O.D. X .035 - 5250 AL. ALLOY TUBE

CHECK VALVE PARTS IN 4435 - 51

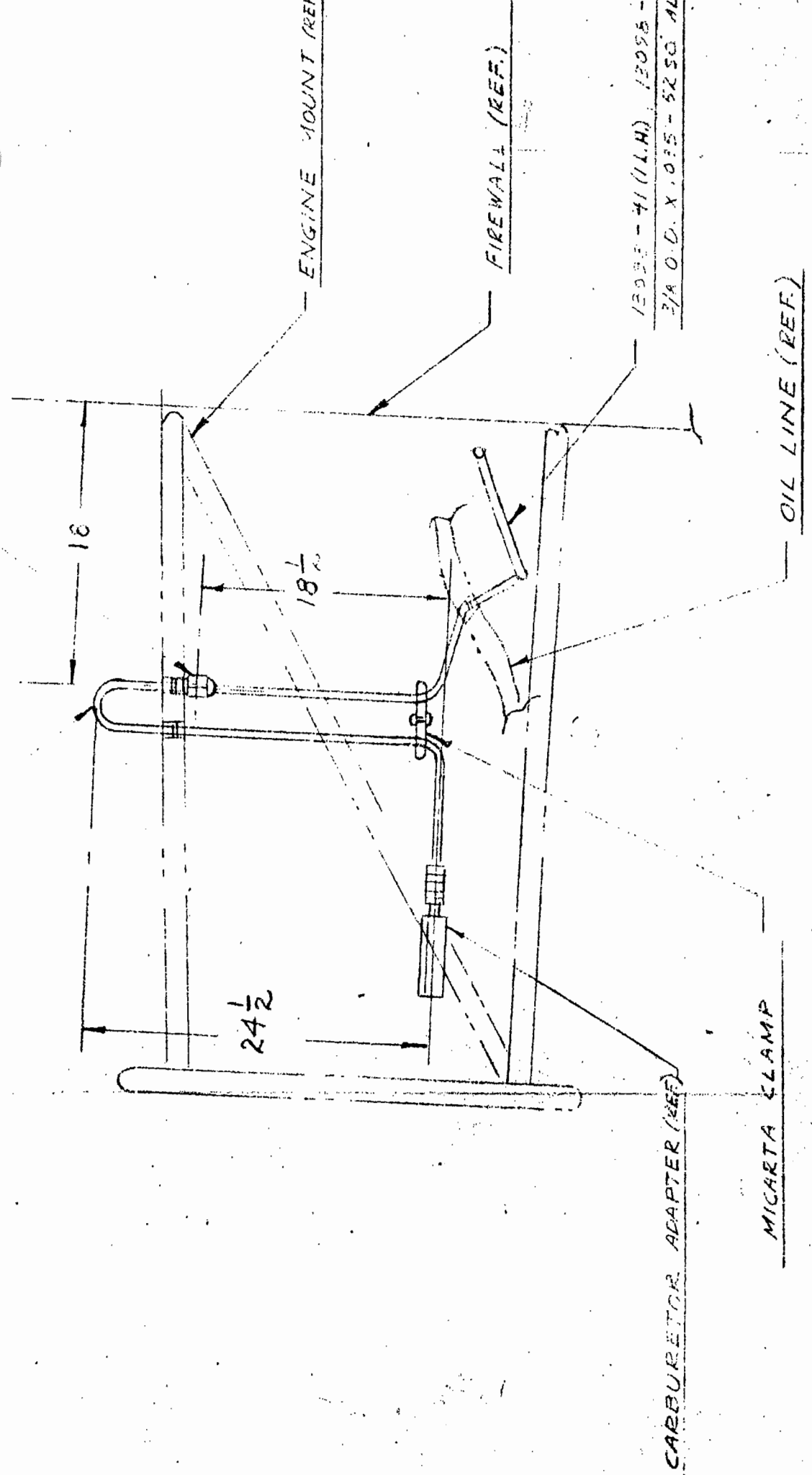

NEW LOCATION - VACUUM CHECK VALVE

FIGURE 1

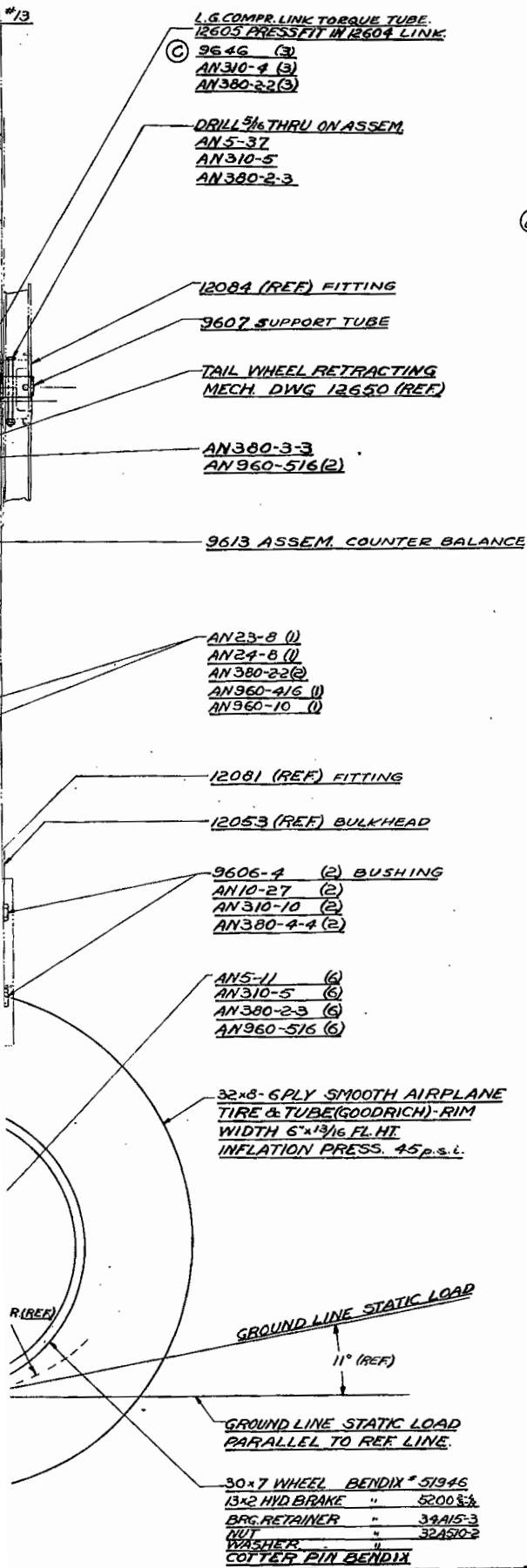

NOTES:

1. TURNS OF HANDCRANK REQUIRED TO RAISE LANDING GEAR - 41
2. TIME REQUIRED TO RAISE LANDING GEAR - 40 SEC.
3. TIME REQUIRED TO LOWER LANDING GEAR - 25 SEC.
4. FILL HAND CRANK GEAR BOX WITH GULF PRIDE OIL - SAE 90 OR EQUIV.
5. FILL WORM GEAR BOXES WITH KENDALL GEAR LUBE #800.
6. ● DENOTES ZERK LUBRICATORS.
- (D) 7. TO ADJUST LANDING GEAR DISCONNECT OPERATING SHAFTS. INSERT AND TIGHTEN THREE NEW 9646 BOLTS BETWEEN FLANGED TORQUE TUBE AND COMPRESSION LINK ON EACH SIDE OF SHIP. TURN HAND CRANK IN "DOWN" DIRECTION UNTIL HARD AGAINST STOP. RELEASE ALL AIR FROM BOTH SHOCK STRUTS AND RAISE WHEELS UNTIL SHOCK STRUTS ARE FULLY COMPRESSED. TURN FLANGE ON EACH WORM GEAR BOX IN "UP" DIRECTION UNTIL ALL LOST MOTION IS TAKEN UP. BOLT UP MATING HOLES IN OPERATING SHAFT FLANGES. LOWER WHEELS UNTIL SHOCK STRUTS ARE FULLY EXTENDED. PRESS IN ON STRUT AND KNUCKLE SHOULD OPEN ABOUT $\frac{3}{16}$. CHECK FULLY COMPRESSED POSITION AGAIN. KNUCKLE SHOULD REMAIN CLOSED.

LANDING GEAR INSTALLATION MODEL G-21A 12600

Fig. 6

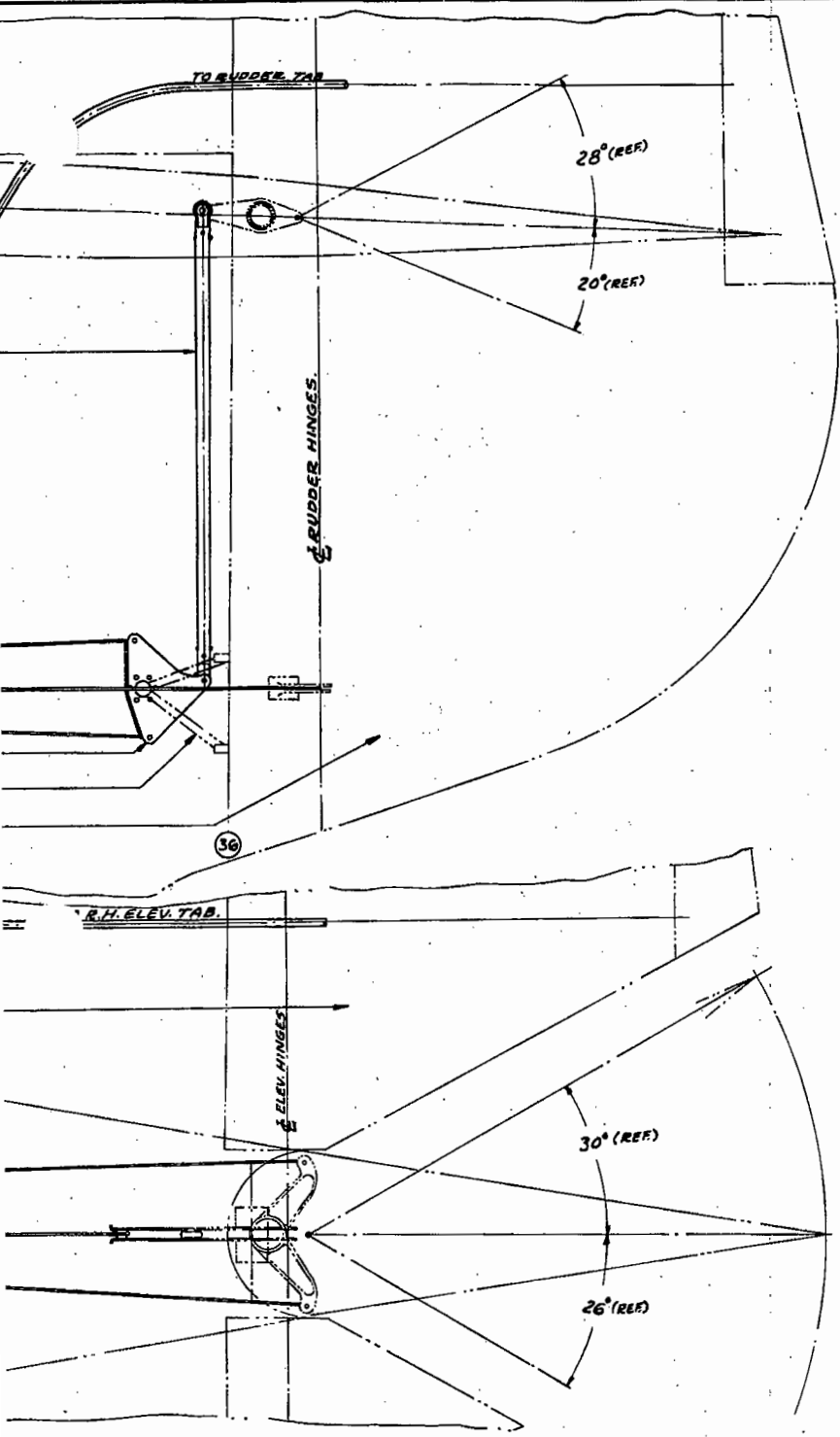

PLAN VIEW OF ELEVATORS & RUDDER.

ELEVATOR & RUDDER CONTROLS MODEL G-21A

Fig. 22

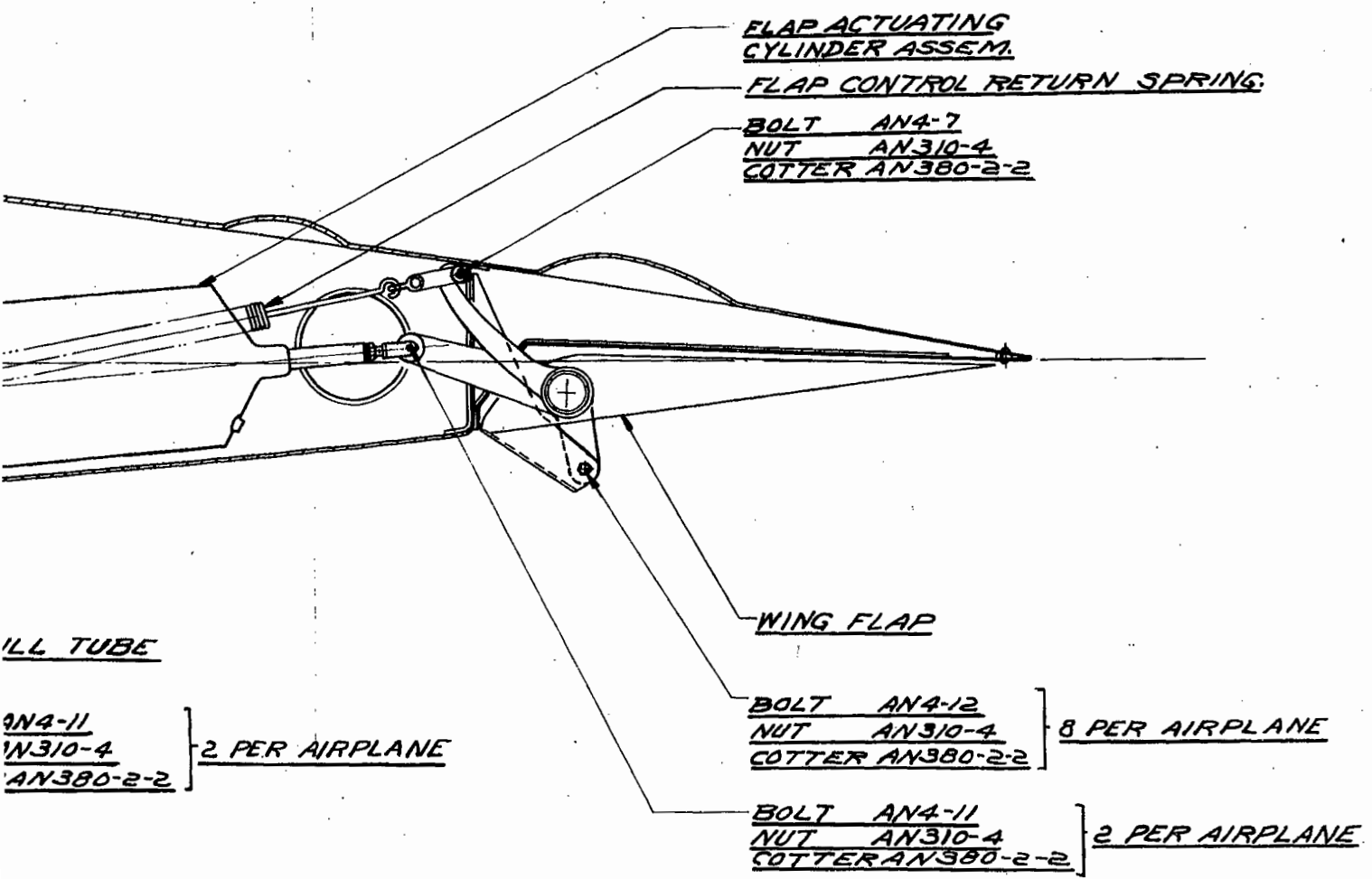

ILL TUBE

AN4-11
AN310-4
AN380-2-2 } 2 PER AIRPLANE



WING CONNECTIONS
MODEL-G 21A

AN4-14
AN310-4
AN380-2-2 } 6 PER AIRPLANE
G. 51K-5

TORQUE TUBE

NOTES:

FIN & RUDDER ON & OF AIRPLANE
STABILIZER & ELEV. + 14° TO & RET.
(801° TO FINPOST.)

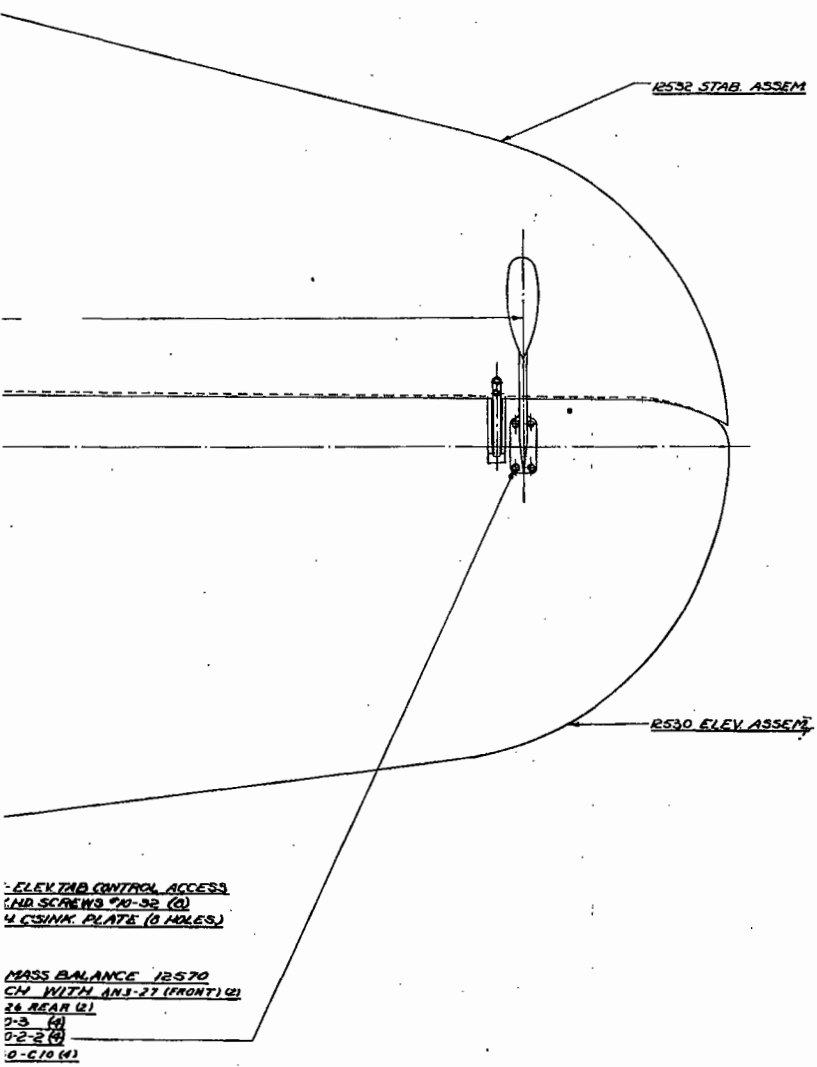

TAIL ERECTION
INSTALLATION
MODEL G-21A
12580

Fig. 5

NOTES:

1. SEAL ALL FASTENINGS THROUGH WATER TIGHT COMPARTMENTS WITH P.A.W. SEALING TAPE.
2. STAKE ALL HEX NUTS BY PEICK PUNCHING.
3. FILL LINES AND CYLINDERS COMPLETELY AND RESERVOIR THREE QUARTERS FULL WITH HYDRAULIC BRAKE FLUID - LOCKHEED SPECIAL #5 OR EQUIVALENT

NUT-PARKER 5BT-D (2)
SLEEVE-PARKER 5T-D (2)

HOSE & GASKET ASSEM.
WEATHERHEAD CO. # 80871-600.

G12-8 (6) CLIP
AN 520-10-8 (6)
AN 345-10 (6)
TAPE HOSE UNDER CLIP

TAPE HOSE NEAR NUT
& SHELLAC TAPE.

BRAKE CONTROLS

MODEL G-21A

12680

Fig. 12